

# KA2201

# 1.2W AUDIO POWER AMP

## INTRODUCTION

The KA2201 is a monolithic integrated audio amplifier. It is designed for audio frequency class B amplifier.

## FEATURES

- Wide operating supply voltage:  $V_{CC} = 3V \sim 14V$
- Medium output power.  
 $P_O = 1.2W$  at  $V_{CC} = 9V$ ,  $R_L = 8\Omega$ , THD = 10%.
- Low quiescent circuit current ( $I_{CCQ} = 4mA$ : Typ).
- Good ripple rejection.
- Minimum number of external parts required.

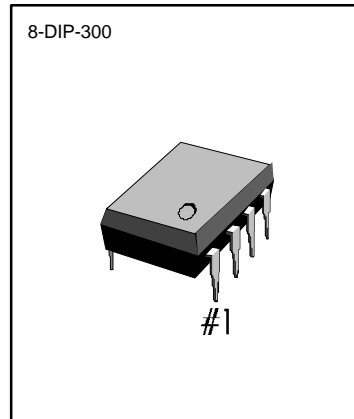

## ORDERING INFORMATION

Device	Package	Operating Temperature
KA2201	8-DIP-300	-20°C ~ +70°C

## BLOCK DIAGRAM

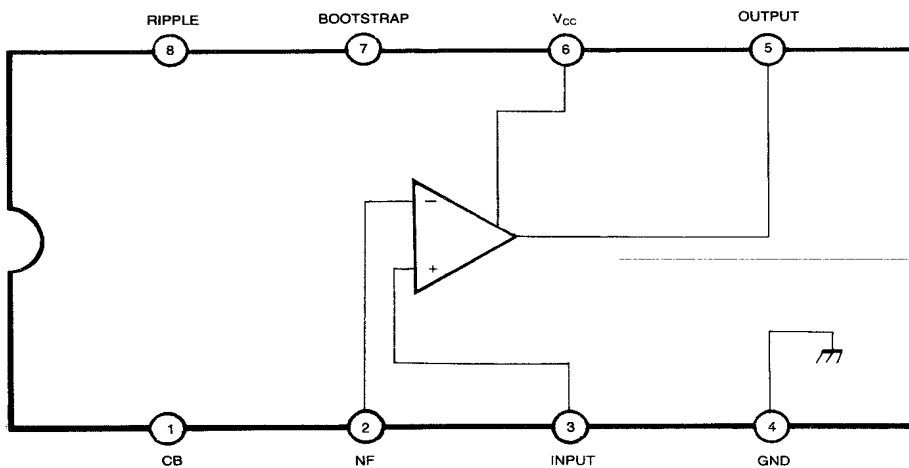

Fig. 1

**ABSOLUTE MAXIMUM RATINGS**

Characteristic	Symbol	value	Unit
Supply Voltage	$V_{CC}$	16	V
Output Peak Current	$I_{PK}$	1.5	A
Power Dissipation	$P_D$	1.25	W
Operating Temperature	$T_{OPR}$	- 20 ~ + 70	°C
Storage Temperature	$T_{STG}$	- 40 ~ + 150	°C

**ELECTRICAL CHARACTERISTICS**

( $T_a = 25^\circ\text{C}$ ,  $V_{CC} = 9\text{V}$ ,  $f = 1\text{KHz}$ ,  $R_G = 600\Omega$ ,  $R_F = 120\Omega$ ,  $R_L = 8\Omega$ , unless otherwise specified)

Characteristic	Symbol	Test Conditions	Min	Typ	Max	Unit
Quiescent Circuit Current	$I_{CCQ}$	$V_i = 0$		4	12	mA
Output Power	$P_O$	$V_{CC} = 9\text{V}$ , $R_L = 4\Omega$ , THD = 10%	0.9	1.6		W
		$V_{CC} = 9\text{V}$ , $R_L = 8\Omega$ , THD = 10%		1.2		
		$V_{CC} = 6\text{V}$ , $R_L = 4\Omega$ , THD = 10%		0.75		
		$V_{CC} = 6\text{V}$ , $R_L = 8\Omega$ , THD = 10%	0.4	0.5		
		$V_{CC} = 12\text{V}$ , $R_L = 8\Omega$ , THD = 10%		2		
Total Harmonic Distortion	THD	$P_O = 500\text{mW}$		0.3	1.0	%
Open Loop Voltage Gain	$G_{VO}$	$R_F = 0$		75		dB
Closed Loop Voltage Gain	$G_{VC}$	$R_F = 120\Omega$	33	36	39	dB
Input Resistance	$R_i$			5		$M\Omega$
Output Noise Voltage	$V_{NO}$	$R_G = 10\text{K}\Omega$ BW (-3dB) = 50Hz-20KHz		0.3	1.0	mV

**TEST CIRCUIT**

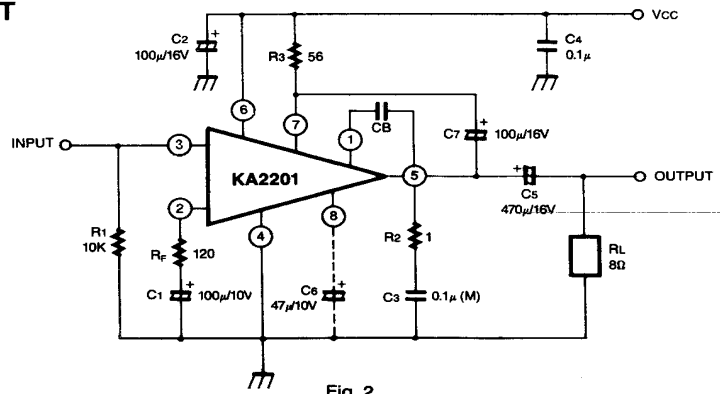
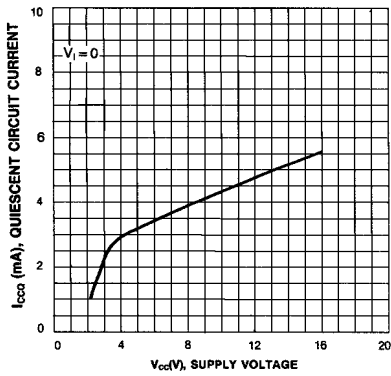
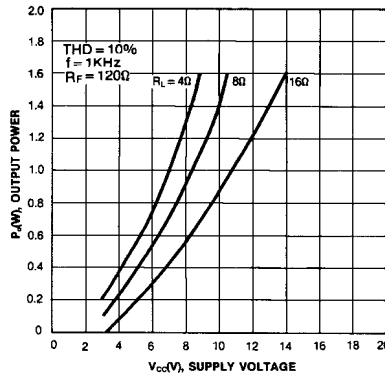

Fig. 2

QUIESCENT CIRCUIT CURRENT—SUPPLY VOLTAGE



OUTPUT POWER-SUPPLY VOLTAGE



FREQUENCY RESPONSE

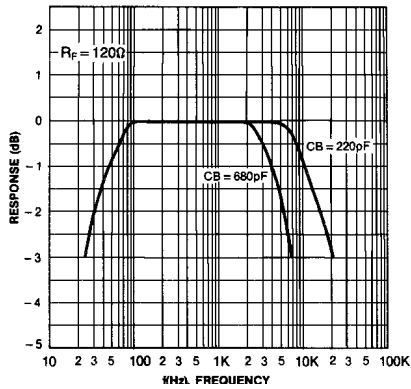

TOTAL HARMONIC DISTORTION-FREQUENCY

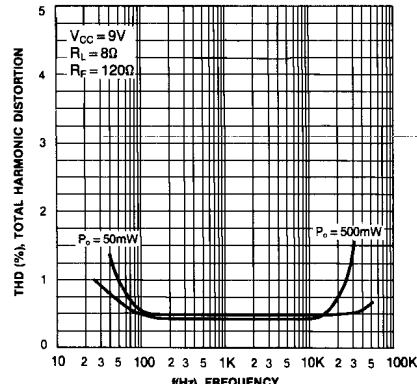

TOTAL HARMONIC DISTORTION-OUTPUT POWER

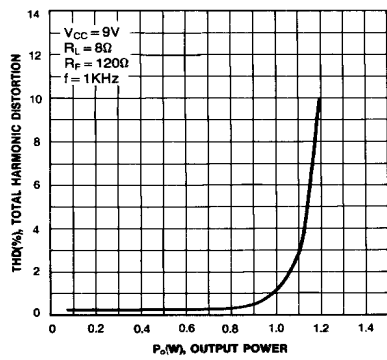

VOLTAGE GAIN-FEEDBACK RESISTANCE

