

DRAN30/60 SERIES

AC - DC DIN RAIL MOUNTABLE POWER SUPPLY
INDUSTRIAL CONTROL EQUIPMENT



FEATURES

- UL / cUL / TUV / CE
- UNIVERSAL INPUT 85~264VAC
- SHORT CIRCUIT PROTECTION
- INTERNAL INPUT FILTER
- 3 YEARS WARRANTY



MODEL LIST

DRAN 60- 24 x

Wattage: 05 : 05V OUT 24 : 24V OUT
12 : 12V OUT 48 : 48V OUT

BLANK : SPRING TERMINALS TYPE
A : SCREW TERMINALS TYPE

MODEL LIST

MODEL NO.	INPUT VOLTAGE	OUTPUT WATTAGE	OUTPUT VOLTAGE	OUTPUT CURRENT	EFF. (min.)	EFF. (typ.)
Single Output Models						
DRAN30-05(A)	85~264 VAC	30 WATTS	+ 5 VDC	6 A	77%	79%
DRAN30-12(A)	85~264 VAC	30 WATTS	+ 12 VDC	2.5 A	82%	84%
DRAN30-24(A)	85~264 VAC	30 WATTS	+ 24 VDC	1.25 A	83%	86%
DRAN30-48(A)	85~264 VAC	30 WATTS	+ 48 VDC	0.625A	83%	86%
DRAN60-05(A)	85~264 VAC	50 WATTS	+ 5 VDC	10 A	77%	79%
DRAN60-12(A)	85~264 VAC	60 WATTS	+ 12 VDC	5 A	84%	86%
DRAN60-24(A)	85~264 VAC	60 WATTS	+ 24 VDC	2.5 A	86%	89%
DRAN60-48(A)	85~264 VAC	60 WATTS	+ 48 VDC	1.25 A	86%	89%

SPECIFICATION

All Specifications Typical At Nominal Line, Full Load, 25°C Unless Otherwise Noticed

GENERAL						
Characteristics	Conditions	min.	typ.	max.	unit	
Switching frequency	Vi nom, Io nom	55		135	KHz	
Isolation voltage	Input-Output	3,000 / 4,242			VAC / VDC	
	Input-FG	1,500 / 2,121			VAC / VDC	
	Output-FG	500 / 710			VAC / VDC	
Isolation resistance	Input-Output, @ 500VDC	100			MΩ	
Ambient temperature	Operating at Vi nom	-40		+ 71	°C	
Derating (see derating curve)	Vi nom, from +61°C to +71°C			2.5	% / °C	
Storage temperature	Non operational	-40		+ 85	°C	
Relative humidity	Vi nom, Io nom	20		95	% RH	
Temperature coefficient	Vi nom, Io min			± 0.03	% / °C	



DRAN30/60 SERIES

SPECIFICATION

All Specifications Typical At Nominal Line, Full Load, 25°C Unless Otherwise Noticed

GENERAL						
Characteristics	Conditions		min.	typ.	max.	unit
MTBF	DRAN30 Bellcore Issue 6 @40°C, GB	5V		551,000		Hours
		12V		582,000		Hours
		24V		588,000		Hours
		48V		609,000		Hours
	DRAN60 Bellcore Issue 6 @40°C, GB	5V		498,000		Hours
		12V		504,000		Hours
		24V		520,000		Hours
		48V		531,000		Hours
Altitude during operation	IEC 60068-2-13				4,850	m
Dimension	Spring & Screw terminal type		L90 x W40.5 x D114			mm
Cooling	Free air convection					
Installation position	Vertical (other direction may derating using)					
Pollution degree					2	

INPUT SPECIFICATIONS						
Characteristics	Conditions		min.	typ.	max.	unit
Rated input voltage	Io nom		100		240	VAC
Absolute input max. range	Ta min ... Ta max, Io nom	AC in	85		264	VAC
		DC in	90		375	VDC
Input current	Vi : 115 / 230 VAC, Io nom	DRAN30		560 / 330		mA
	Vi : 115 / 230 VAC, Io nom	DRAN60		1,060 / 590		mA
Rated input current	Vi : 85 VAC, Io nom	DRAN30 / 60			800 / 1,500	mA
Line frequency	Vi nom, Io nom		47		63	Hz
Inrush current	Vi : 115 / 230 VAC , Io nom				20 / 40	A
Power dissipation	DRAN30 / DRAN60 series Vi : 230 VAC, Io nom	5V		8.5 / 12.5		W
		12V		5.6 / 9.0		W
		24V		5.5 / 8.8		W
		48V		4.9 / 7.8		W
Leakage current	Input-Output				0.25	mA
	Input-FG				3.5	mA

OUTPUT SPECIFICATIONS						
Characteristics	Conditions		min.	typ.	max.	unit
Output voltage accuracy (Adjusted before shipment)	Vi nom, Io max		0		+ 1	%
Minimum load	Vi nom		0			%
Line regulation	Io nom, Vi min ...Vi max				± 0.5	%
Load regulation	Vi nom, Io min ...Io nom				± 0.5	%
Voltage trim range	DRAN30 & DRAN60 series Vi nom, 0.8 Io nom	5V	5		5.5	VDC
		12V	12		14	VDC
		24V	24		28	VDC
		48V	48		55	VDC
Rated continuous loading	DRAN30 series Vi nom	5V	6 A @ 5Vdc / 5.4 A @ 5.5 Vdc			
		12V	2.5 A @ 12Vdc / 2.1 A @ 14 Vdc			
		24V	1.25 A @ 24Vdc / 1.05 A @ 28 Vdc			
		48V	0.625 A @ 48Vdc / 0.54 A @ 55 Vdc			
	DRAN60 series Vi nom	5V	10 A @ 5Vdc / 9.0 A @ 5.5 Vdc			
		12V	5 A @ 12Vdc / 4.25 A @ 14 Vdc			
		24V	2.5 A @ 24Vdc / 2.1 A @ 28 Vdc			
		48V	1.25 A @ 48Vdc / 1.08 A @ 55 Vdc			
Hold up time	Vi : 115 / 230 VAC , Io nom		20 / 30			ms
Turn on time	Vi nom, Io nom	DRAN30			1,000	ms
	Vi nom, Io nom → with 3500µF CAP				2,000	ms
	Vi nom, Io nom	DRAN60			1,000	ms
	Vi nom, Io nom → with 7000µF CAP				1,500	ms

DRAN30/60 SERIES

SPECIFICATION

All Specifications Typical At Nominal Line, Full Load, 25°C Unless Otherwise Noticed

OUTPUT SPECIFICATIONS

Characteristics	Conditions	min.	typ.	max.	unit
Rise time	Vi nom, lo nom DRAN30		150		ms
	Vi nom, lo nom → with 3500 μ F CAP		500		ms
	Vi nom, lo nom DRAN60		150		ms
	Vi nom, lo nom → with 7000 μ F CAP		500		ms
Fall time	Vi nom, lo nom			150	ms
Transient recovery time	Vi nom, I ~0.5 lo nom			2	ms
Ripple & noise	Vi nom, lo nom, BW = 20MHz			50	mV
Power back immunity	DRAN30 & DRAN60	5V	7.5		VDC
	Vi nom, lo nom	12V	18		VDC
	I second	24V	35		VDC
		48V	63		VDC
Capacitor load	Vi nom, lo nom DRAN30 / 60			3,500 / 7,000	μ F
DC ON indicator threshold at start up (Green LED)	Vi nom, lo nom	5V	3.5	4.5	VDC
		12V	9.0	10.8	VDC
		24V	18	21.6	VDC
		48V	37	43	VDC
Efficiency	Vi nom, lo nom, Po / Pi	Up to 89%, See model list and typ efficiency curve			

CONTROL AND PROTECTION

Characteristics	Conditions	min.	typ.	max.	unit
Input fuse		T2A / 250VAC internal			
Internal surge voltage protection	IEC 61000-4-5	Varistor			
Rated over load protection	Vi nom (see typ current limited curve)	110		150	%
Power Rdy (for 24V model only)	Threshold voltage of contact closed (at start up)	18.8		19.6	VDC
Over voltage protection	Vi nom, 0.8 lo nom (Auto Recovery)	5V	6.0	6.8	VDC
		12V	15	16.5	VDC
		24V	30	33	VDC
		48V	60	66	VDC
Output short circuit		Fold forward			
Degree of protection		IP20			

APPROVALS AND STANDARDS

UL / cUL	UL 508 Listed UL 60950-1, UL 1310 Class 2 Power (only 5V and DRAN60-12(A) w/o Class 2) Recognized ISA 12.12.01(Class 1, Division 2, Groups A, B, C and D)
TUV	EN 60950-1 EN 61558-1, EN 61558-2-16 (meet EN 60204-1)
CE	EN 61000-6-3, EN 55022 Class B, EN 61000-3-2, EN 61000-3-3 EN 61000-6-2, EN 55024, EN 61000-4-2 Level 4, EN 61000-4-3 Level 3 EN 61000-4-4 Level 4, EN 61000-4-5 L-N Level 3, L / N-FG Level 4 EN 61000-4-6 Level 3, EN 61000-4-8 Level 4, EN 61000-4-11 ENV 50204 Level 2, EN 61204-3
CCC	GB4943.1, GB9254, GB17625.1
Vibration resistance	meet IEC 60068-2-6 (Mounting by rail : 10-500 Hz, 2G, along X, Y, Z each Axis, 60 min for each Axis)
Shock resistance	meet IEC 60068-2-27 (15G, 11ms, 3 Axis, 6 Faces, 3 times for each Face)

PHYSICAL CHARACTERISTICS

Case size	90 x 40.5 x 114 mm (3.6 x 1.59 x 4.49 inches)		
Case material	Plastic		
Weight	DRAN30 : 270 g	DRAN60 : 340 g	
Packing	DRAN30 : 0.35 kg ; 40 pcs / 15 kg / 2.16 CUFT	DRAN60 : 0.41 kg ; 40 pcs / 17.5 kg / 2.16 CUFT	

DRAN30/60 SERIES

MECHANISM & PIN CONFIGURATION

mm [inch]

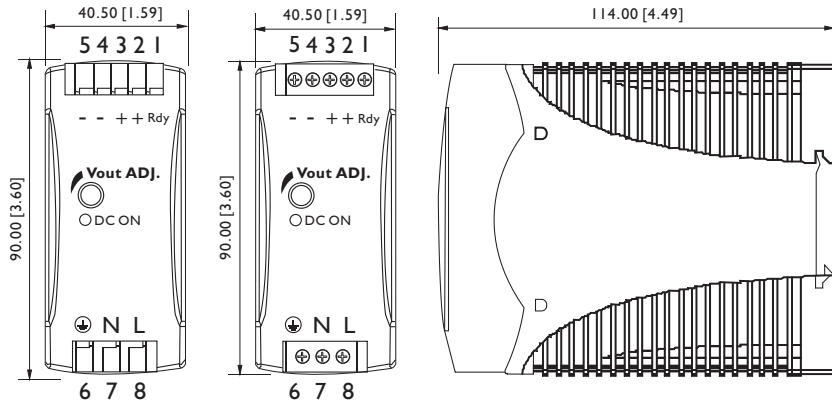

CONSTRUCTION

Easy snap-on mounting onto the DIN-Rail (TS35/7.5 or TS35/15), unit sits safely and firmly on the rail.

INSTALLATION

Ventilation / Cooling
Normal convection
All sides 25mm free space
For cooling recommended
Connector size range
Spring terminal:
AWG24-14 (0.2~2mm²) flexible / solid cable, 10 m/m stripping at cable end recommends
Screw terminal:
AWG26-12 (0.2~2.5mm²) flexible / solid cable, connector can withstand torque at maximum 5 pound-inches.
4-5 m/m stripping at cable end recommends
Use copper conductors only, 60 / 75°C

GENERAL TOLERANCE	
0.00[0.00] - 30.00[1.18]	±0.30[0.01]
30.00[1.18] - 120.00[4.72]	±0.50[0.02]

PIN ASSIGNMENT

PIN NO.	Designation	Description
1	RDY	DC OK output for relay (not connect except 24V model)
2	+	Positive output terminal
3	+	Positive output terminal
4	-	Negative output terminal
5	-	Negative output terminal
6	⊕	Ground this terminal to minimize high-frequency emissions
7	N	Input terminals (neutral conductor, no polarity at DC input)
8	L	Input terminals (phase conductor, no polarity at DC input)
	Vout ADJ.	Trimmer-potentiometer for Vout adjustment
	DC ON	Operation indicator LED

Fig. 1 Rdy connection

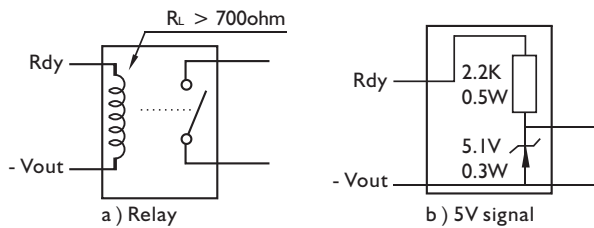

CIRCUIT SCHEMATIC

• Block diagram

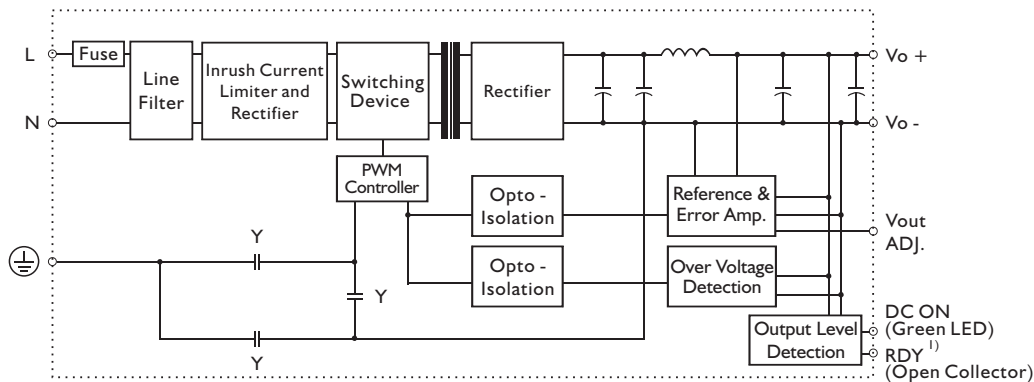

Note: 1) for 24V Model Only

DRAN30/60 SERIES

TYP. CURRENT LIMITED CURVE

DRAN30-24(A)

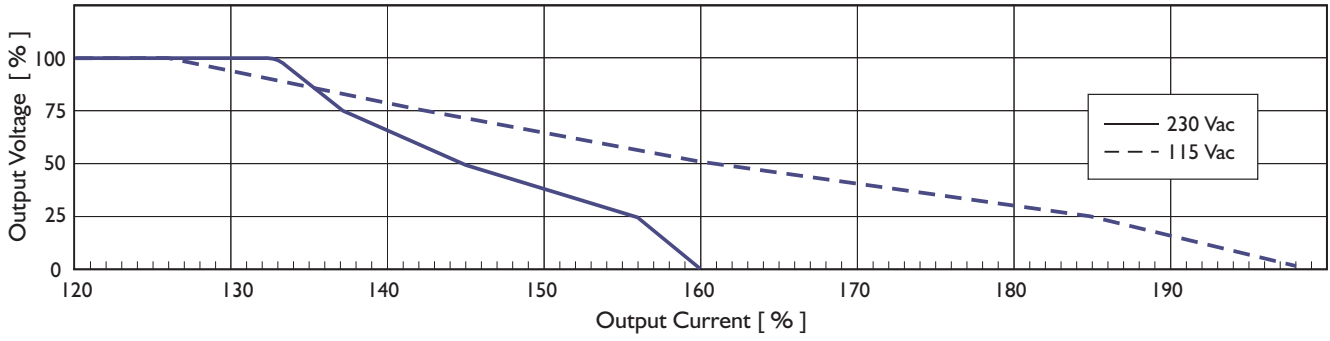

DRAN60-24(A)

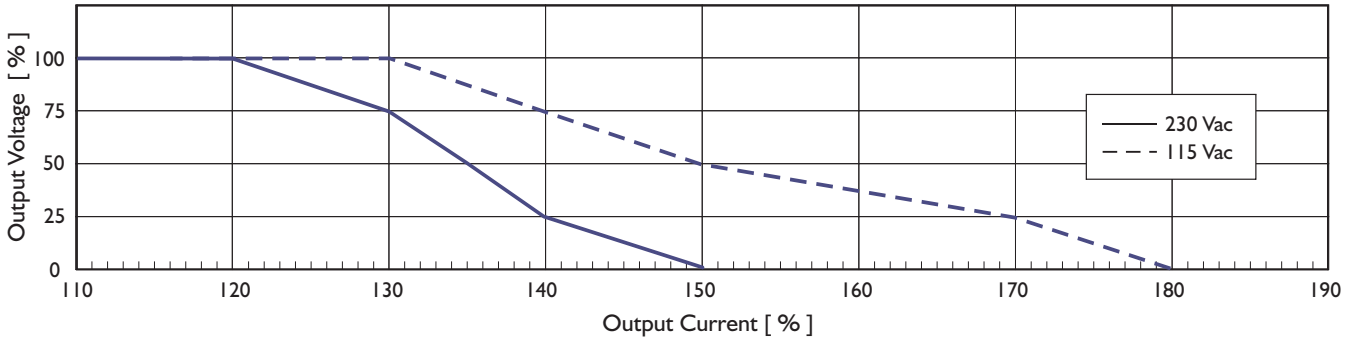

DERATING CURVE

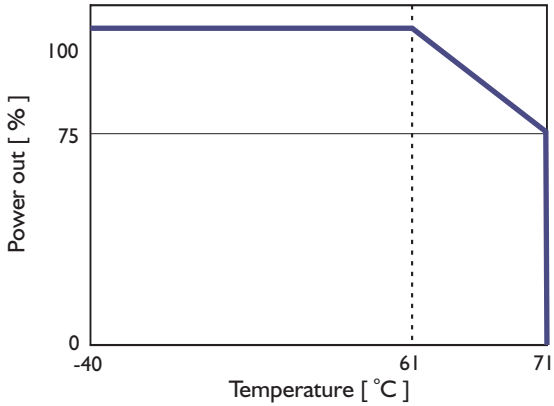

TYP. EFFICIENCY CURVE

DRAN30-24(A)

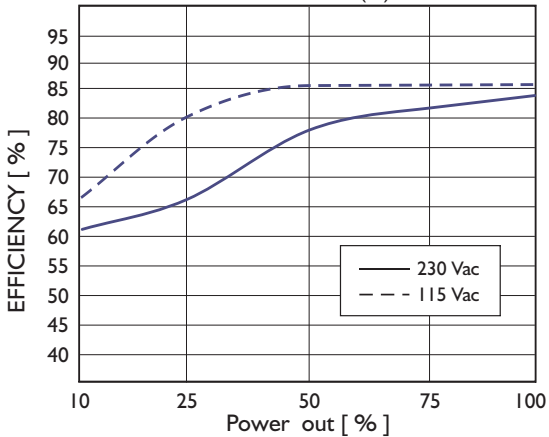

DRAN60-24(A)

