

### Features

- Operating Voltage: 2.0V~5.5V
- Maximum input serial clock: 500kHz at  $V_{DD}=2V$ , 2MHz at  $V_{DD}=5V$
- Operating current: less than 300nA at 2V, less than 1 $\mu$ A at 5V
- TTL compatible
  - $V_{IH}$ : 2.0V~ $V_{DD}+0.3V$  at  $V_{DD}=5V$
  - $V_{IL}$ : -0.3V~+0.8V at  $V_{DD}=5V$
- Two data transmission modes: Single-byte, or Multiple-byte (Burst mode)
- Serial I/O transmission
- All registers store BCD format

### Applications

- Microcomputer serial clock
- Clock and Calendar

### General Description

The HT1380 is a serial timekeeper IC which provides seconds, minutes, hours, day, date, month and year information. The number of days in each month and leap years are automatically adjusted. Also, the HT1380 is designed for low power consumption and can operate in one of two formats: a 12-hour mode with an AM/PM indicator, or a 24-hour mode.

corresponding information. A 32.768kHz off-chip crystal is required to provide the correct timing. In order to minimize the pin number, the HT1380 uses a serial I/O transmission method to interface with a microprocessor. Only three wires are required; (1) $\overline{RST}$ , (2)SCLK and (3)I/O. Data can be delivered 1 byte at a time or in a burst of up to 8 bytes.

The HT1380 has several registers to store the

### Block Diagram

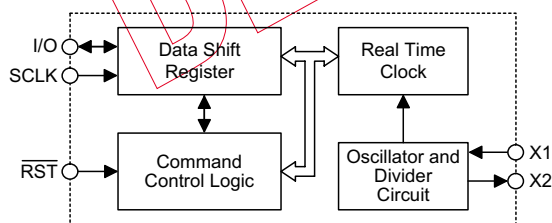

### Pin Assignment

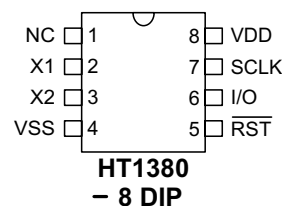

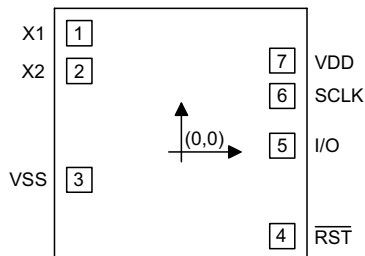
**Pad Assignment**

**Pad Coordinates**

 Unit:  $\mu\text{m}$ 

Pad No.	X	Y	Pad No.	X	Y
1	-1060.5	1000	5	1050.6	54.15
2	-1060.5	683.13	6	1050.8	472.16
3	-1060.5	-236.14	7	1050.4	770.21
4	1050.62	-710			

 Chip size:  $2480 \times 2390 (\mu\text{m})^2$ 

\* The IC substrate should be connected to VSS in the PCB layout artwork.

**Pad Description**

Pad No.	Pin Name	I/O	Description
1	X1	I	Off-chip 32.768kHz crystal input pad
2	X2	O	Oscillator output
3	VSS	—	Negative power supply (GND)
4	$\overline{\text{RST}}$	I	The reset pad with serial transmission
5	I/O	I/O	The data input/output pad with serial transmission
6	SCLK	I	The serial clock pulses pad with serial transmission
7	VDD	—	Positive power supply

**Absolute Maximum Ratings**

Supply Voltage.....	-0.3V to 5.5V	Storage Temperature.....	-50°C to 125°C
Input Voltage.....	$V_{\text{SS}}-0.3\text{V}$ to $V_{\text{DD}}+0.3\text{V}$	Operating Temperature .....	0°C to 70°C

Note: These are stress ratings only. Stresses exceeding the range specified under "Absolute Maximum Ratings" may cause substantial damage to the device. Functional operation of this device at other conditions beyond those listed in the specification is not implied and prolonged exposure to extreme conditions may affect device reliability.

**D.C. Characteristics**

Ta=25°C

Symbol	Parameter	Test Conditions		Min.	Typ.	Max.	Unit
		V <sub>DD</sub>	Conditions				
V <sub>DD</sub>	Operation Voltage	—	—	2	—	5.5	V
I <sub>STB</sub>	Standby Current	2V	—	—	—	100	nA
		5V		—	—	—	100
I <sub>DD</sub>	Operating Current	2V	No load	—	—	0.3	μA
		5V		—	—	—	1.0
I <sub>OH</sub>	Source Current	2V	V <sub>OH</sub> =1.8V	-0.2	-0.4	—	mA
		5V	V <sub>OH</sub> =4.5V	-0.5	-1.0	—	mA
I <sub>OL</sub>	Sink Current	2V	V <sub>OL</sub> =0.2V	0.7	1.5	—	mA
		5V	V <sub>OL</sub> =0.5V	2.0	4.0	—	mA
V <sub>IH</sub>	"H" Input Voltage	5V	—	2	—	—	V
V <sub>IL</sub>	"L" Input Voltage	5V	—	—	—	0.8	V
f <sub>OSC</sub>	System Frequency	5V	32.768kHz X'TAL	—	32.768	—	kHz
f <sub>SCLK</sub>	Serial Clock	2V	—	—	—	0.5	MHz
		5V	—	—	—	2	MHz

Note: I<sub>STB</sub> is specified with SCLK, I/O, RST open. The clock halt bit must be set to logic one (oscillator disabled).

**A.C. Characteristics**

Ta=25°C

Symbol	Parameter	V <sub>DD</sub>	Min.	Max.	Unit
t <sub>DC</sub>	Data to Clock Setup	2V	200	—	ns
		5V	50	—	
t <sub>CDH</sub>	Clock to Data Hold	2V	280	—	ns
		5V	70	—	
t <sub>CDD</sub>	Clock to Data Delay	2V	—	800	ns
		5V	—	200	
t <sub>CL</sub>	Clock Low Time	2V	1000	—	ns
		5V	250	—	
t <sub>CH</sub>	Clock High Time	2V	1000	—	ns
		5V	250	—	

Symbol	Parameter	V <sub>DD</sub>	Min.	Max.	Unit
f <sub>CLK</sub>	Clock Frequency	2V	—	0.5	MHz
		5V	D.C.	2.0	
t <sub>r</sub> t <sub>f</sub>	Clock Rise and Fall Time	2V	—	2000	ns
		5V	—	500	
t <sub>CC</sub>	Reset to Clock Setup	2V	4	—	us
		5V	1	—	
t <sub>CCH</sub>	Clock to Reset Hold	2V	240	—	ns
		5V	60	—	
t <sub>CWH</sub>	Reset Inactive Time	2V	4	—	μs
		5V	1	—	
t <sub>CDZ</sub>	Reset to I/O High Impedance	2V	—	280	ns
		5V	—	70	

### Functional Description

The HT1380 mainly contains the following elements: a data shift register array to store the clock/calendar data, command control logic, oscillator circuit and read timer clock. Two modes are available to transfer the data from and to the HT1380. The two modes are single-byte mode and multiple-byte.

To initiate any transfer of data,  $\overline{RST}$  is taken high and an 8-bit command byte is first loaded into the control logic to provide the register address and command information. Following the command word, the clock/calendar data is transferred to or from the corresponding register serially. The  $\overline{RST}$  pin must be taken low again after the transfer operation is completed. All data is entered on the rising edge of SCLK and outputs on the falling edge of SCLK. In total, 16 clock pulses are needed for byte mode and 72 of those for burst mode. Both input and output data starts with bit 0.

The HT1380 also contains two additional bits, the clock halt bit (CH) and the write protect bit (WP). These bits control the operation of the oscillator and so data can be written to the register array. These two bits should first be

specified in order to read from and write to the register array properly.

### Command byte

For each data transfer, a command byte is initiated to specify which register is accessed. This is to decide whether a read, write, or test cycle is operated and whether a byte or burst mode transfer is to occur. The command byte is shown as follows:

Bit	7	6	5	4	3	2	1	0
	1	0	0	A3	A2	A1	A0	R/ $\overline{W}$

A0~A2 : The address the of register

A3 : 1 for test mode, 0 for normal mode

R/ $\overline{W}$  : 1 for read cycle, 0 for write cycle

The LSB set to logic zero (one), represents a write (read) cycle is to take place. Bit1~bit3 specify the designated registers to be accessed. If the command byte is 1001xxx1, the HT1380 is configured while in Test mode. The Test mode is used by Holtek only for testing purposes. If used generally, unpredictable conditions may occur.

The following table shows the register address and its data format:

Register Address A2~A0	Function	Command Address (HEX)	Write=W Read=R	Range Data (BCD)	Register Definition							
					7	6	5	4	3	2	1	0
0	Seconds	80	W	00~59	CH	10 SEC			SEC			
		81	R									
1	Minutes	82	W	00~59	0	10 MIN			MIN			
		83	R									
2	12HRS 24HRS	84	W	01~12	12\	0	AP	HR	HOUR			
		85	R	00~23	24	0	10	HR				
3	Date	86	W	01~31	0	0	10 DATE		DATE			
		87	R									
4	Month	88	W	01~12	0	0	0	10M	MONTH			
		89	R									
5	Day	8A	W	01~07	0	0	0	0	DAY			
		8B	R									
6	Year	8C	W	00~99	10 YEAR			YEAR				
		8D	R									
7	Write Protect	8E	W	00~80	WP	ALWAYS ZERO						
		8F	R									

CH: Clock Halt bit  
 CH=0 oscillator enabled  
 CH=1 oscillator disabled

WP: Write protect bit  
 WP=0 register data can be written in  
 WP=1 register data can not be written in

Bit 7 of Reg2: 12/24 mode flag  
 bit 7=1, 12-hour mode  
 bit 7=0, 24-hour mode

Bit 5 of Reg2: AM/PM mode defined  
 AP=1 PM mode  
 AP=0 AM mode

#### Clock halt bit

Bit 7 of the seconds register is defined as the clock halt bit (CH). When this bit is set to logic 1, the clock oscillator is stopped and the HT1380 is placed into a low-power standby mode. When this bit is written to logic 0, the clock will start.

#### Write protect register

Data can be written into the designated register only if the write protect bit (WP), the MSB of write protect register is set to logic 0. The write protect register can be accessed using the command \$8E or \$8F. The write protect bit cannot be written to in burst mode.

#### Reset and Clock control

The  $\overline{\text{RST}}$  pin is used to enable the HT1380. When the  $\overline{\text{RST}}$  pin is taken high, the built-in control logic is turned on and the address/command sequence can access the corresponding shift register. The  $\overline{\text{RST}}$  pin is also used to terminate either single byte or multiple byte data transfer. The user should take the  $\overline{\text{RST}}$  pin low again after every data transfer operation is completed. The input of SCLK is a sequence of a falling edge followed by a rising edge. For data inputs, the data must be valid during the rising edge of SCLK. The data bits are outputs on the falling edge of the clock. All data transfer terminates if the  $\overline{\text{RST}}$  input is low and the I/O pin goes to a high impedance state.

**Burst mode**

When the command byte is \$BE (or \$BF), the HT1380 is configured in burst mode. In this mode the eight clock/calendar registers can be consecutively written (or read) starting with bit 0 of register address 0.

**Data in and Data out**

In writing a data byte for the HT1380, the user should first input the "write command byte" and follow with the corresponding data byte on the rising edge of the next eight SCLK cycles. Additional SCLK cycles are ignored. Data is entered starting with bit 0.

In reading a data byte from the HT1380, a "read command byte" should first be entered. The data bit outputs on the falling edge of the next eight SCLK cycles. Note that the first data bit to be transmitted on the first falling edge after

the last bit of the "read command byte" is written. Additional SCLK cycles re transmits the data bytes as long as RST remains on a high level. Data outputs starting with bit 0.

**Crystal selection**

A 32.768Khz crystal can be directly connected to the HT1380 via pin 2 and 3 (X1, X2). In order to obtain the correct frequency, two additional load capacities (C1, C2) are needed. The value of the capacity depends on how accurate the crystal is. We suggest that you can follow the table which suggests the value of capacities.

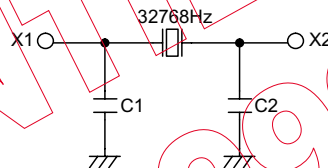

The following diagram shows the single and burst  $\mu$

**Single byte transfer**

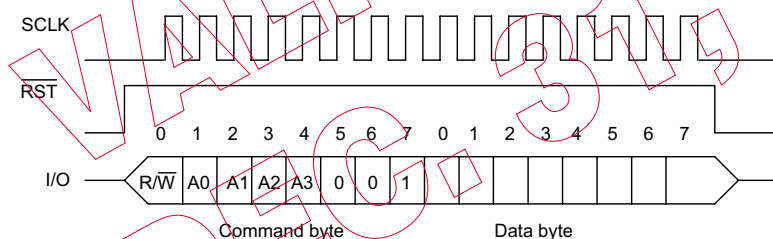

**Burst mode transfer**

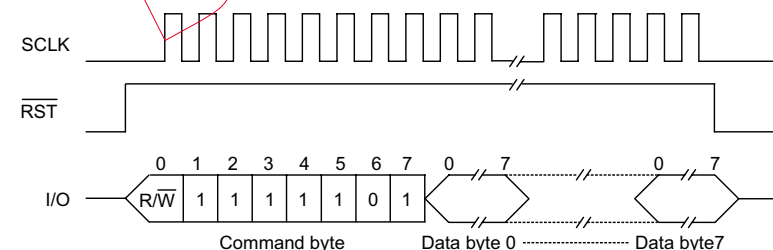

The table illustrates the suggestion value of capacities (C1, C2)

Crystal Error	Capacity Value
10 ppm	8p
10~20 ppm	12p

Flow Chart

- To disable write protect (WP=0) bit and enable the oscillator (CH=0)

- Single byte data transfer

- Burst mode data transfer

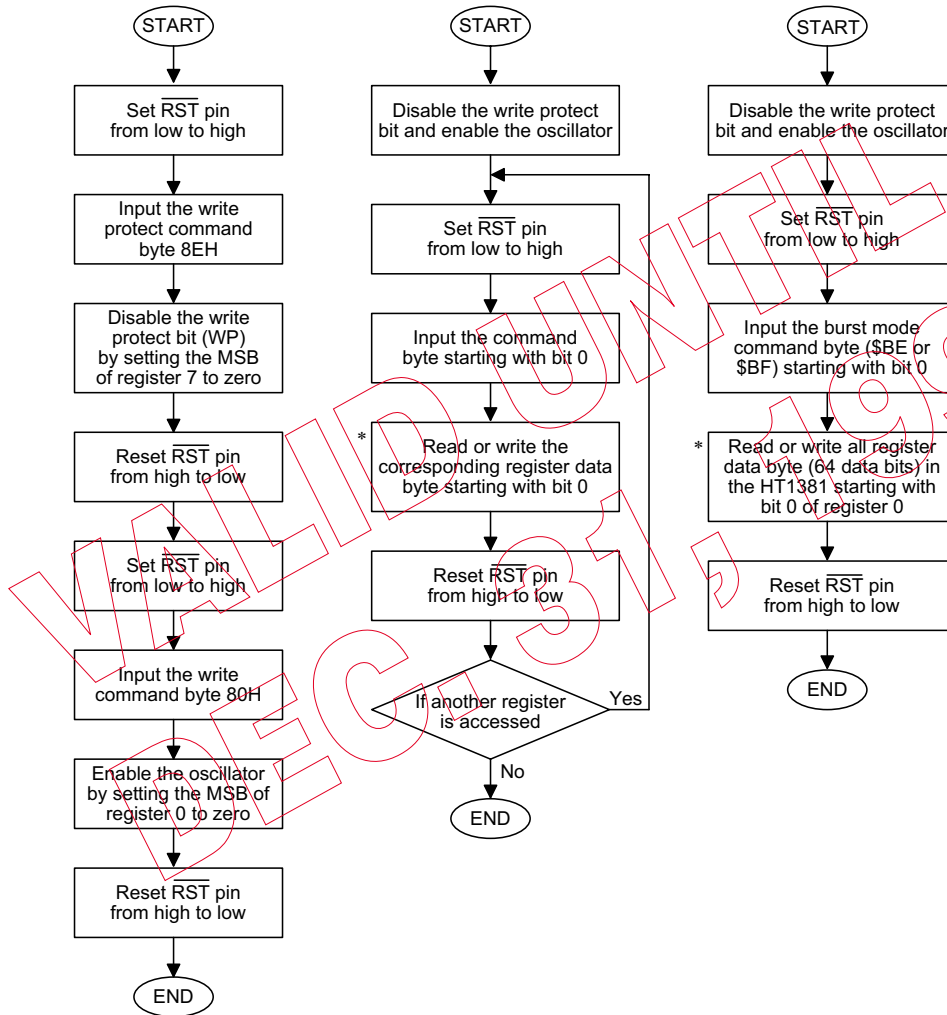

\*Note: In reading the data byte from HT1380 register, the first data bit to be transmitted at the first falling edge after the last bit of the command byte is written.

### Timing Diagrams

#### Read data transfer

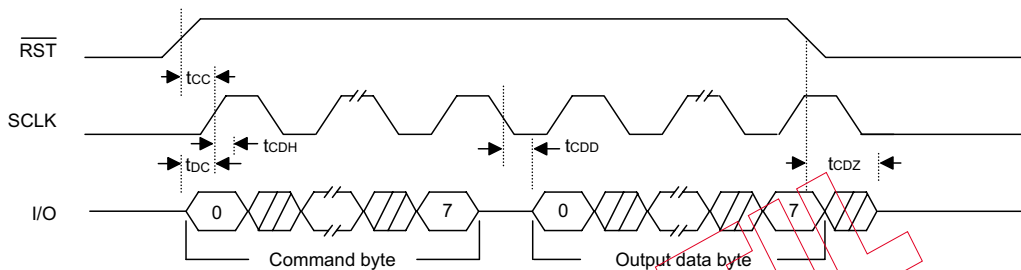

#### Write data transfer

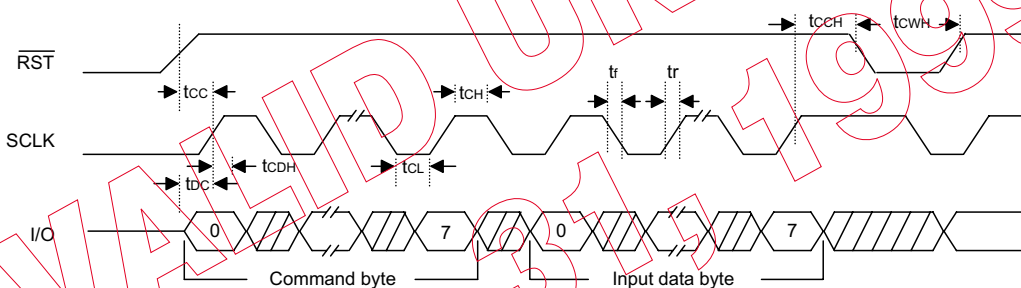

### Application Circuits

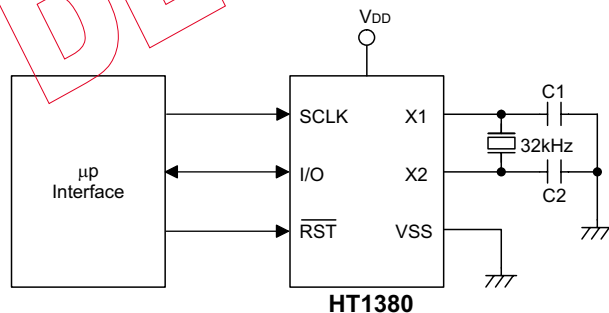



VALID UNTIL  
DEC. 31, 1999

Holtek Semiconductor Inc. (Headquarters)  
No.3 Creation Rd. II, Science-based Industrial Park, Hsinchu, Taiwan, R.O.C.  
Tel: 886-3-563-1999  
Fax: 886-3-563-1189

Holtek Semiconductor Inc. (Taipei Office)  
5F, No.576, Sec.7 Chung Hsiao E. Rd., Taipei, Taiwan, R.O.C.  
Tel: 886-2-2782-9635  
Fax: 886-2-2782-9636  
Fax: 886-2-2782-7128 (International sales hotline)

Holtek Semiconductor (Hong Kong) Ltd.  
RM.711, Tower 2, Cheung Sha Wan Plaza, 833 Cheung Sha Wan Rd., Kowloon, Hong Kong  
Tel: 852-2-745-8288  
Fax: 852-2-742-8657

Copyright © 1999 by HOLTEK SEMICONDUCTOR INC.

The information appearing in this Data Sheet is believed to be accurate at the time of publication. However, Holtek assumes no responsibility arising from the use of the specifications described. The applications mentioned herein are used solely for the purpose of illustration and Holtek makes no warranty or representation that such applications will be suitable without further modification, nor recommends the use of its products for application that may present a risk to human life due to malfunction or otherwise. Holtek reserves the right to alter its products without prior notification. For the most up-to-date information, please visit our web site at <http://www.holtek.com.tw>.