

# FAN7601

## Green Current Mode PWM Controller

### Features

- Green Current Mode PWM Control
- Low Operating Current: Max 4mA
- Burst Mode Operation
- Internal High Voltage Start-up Switch
- Under Voltage Lockout (UVLO): 12V/8V
- Latch Protection & Soft Start Function
- Over Voltage Protection: 19V
- Operating Frequency up to 300kHz
- Max Duty Cycle: 95%

### Typical Applications

- Off-Line Adapter Applications
- Auxiliary Power Supplies

### Description

The FAN7601 is a green programmable frequency current mode PWM controller. It is specially designed for the off-line adapter application and the auxiliary power supplies which require high efficiency at a light load and no load. The internal high voltage start-up switch and the burst mode reduce the power loss. The FAN7601 includes some protections such as latch protection and over voltage protection. The latch protection can be used for over voltage protection and/or thermal protection and so on. And the soft start prevents the output voltage over shoot at start up.

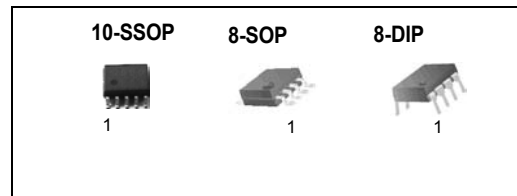

### Internal Block Diagram

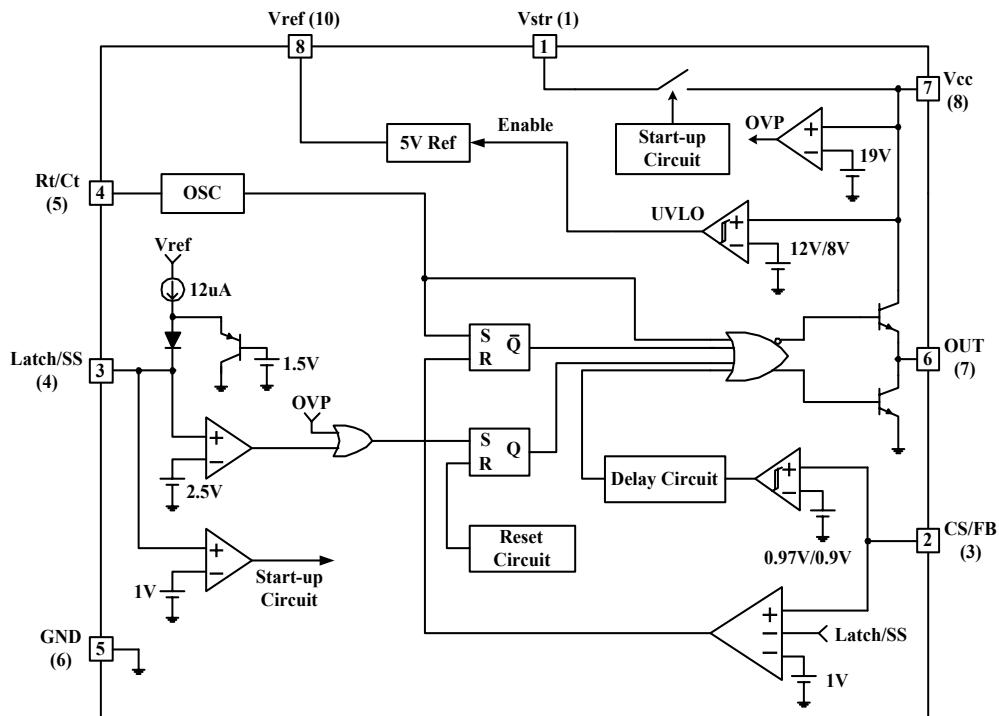

\* ( ) is 10-SSOP PIN Number

## Pin Assignments

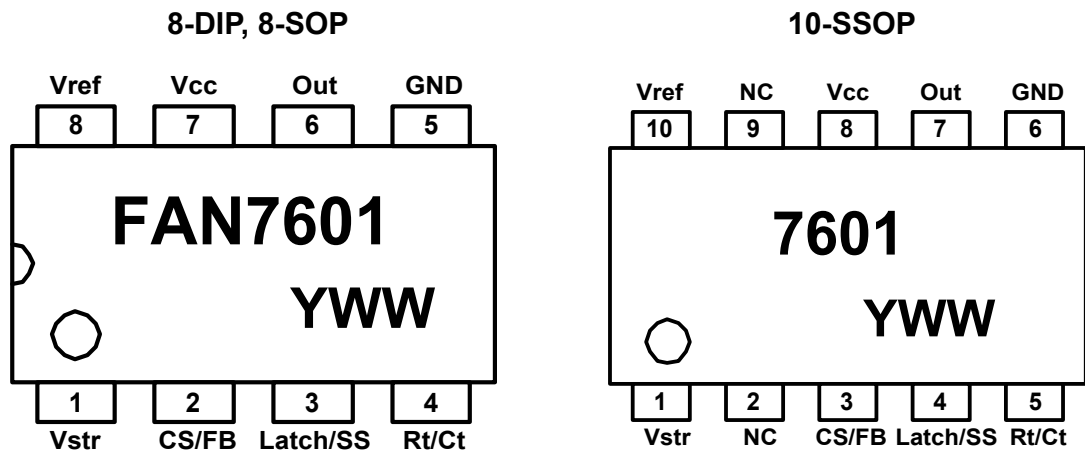

## Pin Definitions

Pin Number	Pin Name	Pin Function Description
1 (1)	Vstr	Start-up
2 (3)	CS/FB	Current Sense and Feedback
3 (4)	Latch/SS	Latch Protection and Soft Start
4 (5)	Rt/Ct	Oscillator Timing
5 (6)	GND	Ground
6 (7)	Out	Gate Drive Output
7 (8)	VCC	IC Power Supply
8 (10)	Vref	Voltage Reference

\*() is 10-SSOP PIN Number

## Absolute Maximum Ratings

(Ta = 25°C, unless otherwise specified)

Characteristics	Symbol	Value	Unit
Supply Voltage	VCC	20	V
Input Voltage CS/FB	VCS/FB	-0.3 to 20	V
Operating Temperature	TOPR	-25 to +125	°C
Storage Temperature	TSTG	-55 to +150	°C
Junction Temperature	Tj	150	°C
Output Current	IO	250	mA
Vstr Input Voltage	Vstr	500	V
ESD Capability, HBM Model (All pins except Vcc and Vstr)	-	2.0	kV
ESD Capability, Machine Model	-	300	V
Thermal Resistance, Junction to Air	8-DIP	100	°C/W
	8-SOP	180	
	10-SSOP	130	

## Electrical Characteristics

( $T_a = -25^{\circ}\text{C} \sim 125^{\circ}\text{C}$ ,  $V_{CC} = 14\text{V}$ ,  $R_t = 9.5\text{k}\Omega$ ,  $C_t = 2.2\text{nF}$  unless otherwise specified)

Characteristics	Symbol	Conditions	Min.	Typ.	Max.	Unit
<b>REFERENCE SECTION</b>						
Reference Output Voltage	$V_{\text{ref}}$	$I_O = 1\text{mA}$	4.85	5.00	5.15	V
Line Regulation	$\Delta V_{\text{ref1}}$	$V_{CC} = 10\text{V} \sim 18\text{V}$	-	10	20	mV
Load Regulation	$\Delta V_{\text{ref2}}$	$I_O = 1\text{mA} \sim 10\text{mA}$	-	20	30	mV
<b>OSCILLATOR SECTION</b>						
Initial Accuracy	FOSC	-	90	100	110	kHz
Voltage Stability	STV	$V_{CC} = 10\text{V} \sim 18\text{V}$	-	1.0	1.5	%
Amplitude	VOCS	$V_{\text{pin4}}$ peak-to-peak	-	1.25	-	V
<b>PWM SECTION</b>						
CS/FB Threshold Voltage1	VCS/FB1	-	0.9	1.0	1.1	V
Maximum Duty Cycle	DMAX	$T_a = 25^{\circ}\text{C}$	92	95	98	%
Minimum Duty Cycle	DMIN	-	-	-	0	%
<b>BURST MODE SECTION</b>						
CS/FB Threshold Voltage2 <sup>(1)</sup>	VCS/FB2	-	0.77	0.97	1.17	V
CS/FB Threshold Voltage3 <sup>(1)</sup>	VCS/FB3	-	0.7	0.9	1.1	V
<b>SOFT START SECTION</b>						
Soft Start Current	ISS	$V_{\text{pin3}} = \text{GND}$	9	12	15	$\mu\text{A}$
Soft Start Limit Voltage <sup>(2)</sup>	VSL	$I_{SS} = 1\mu\text{A}$	1.2	1.5	1.8	V
<b>PROTECTION SECTION</b>						
Latch Voltage	VLATCH	-	2.25	2.5	2.75	V
Over Voltage Protection	VOVP	-	18	19	20	V
<b>UVLO SECTION</b>						
Start Threshold Voltage	$V_{\text{tH}}$	-	11	12	13	V
Minimum Operating Voltage	$V_{\text{tL}}$	-	7	8	9	V
<b>TOTAL CURRENT SECTION</b>						
Operating Supply Current	IOP	-	-	3	4	mA
<b>OUTPUT SECTION</b>						
Low Output Voltage	VOL	$T_a = 25^{\circ}\text{C}$ , $I_O = 100\text{mA}$	-	2	2.5	V
High Output Voltage	VOH	$T_a = 25^{\circ}\text{C}$ , $I_O = -100\text{mA}$	11.5	12	14	V
Rising Time <sup>(1)</sup>	$T_r$	$T_a = 25^{\circ}\text{C}$ , $C_l = 1\text{nF}$	-	45	150	ns
Falling Time <sup>(1)</sup>	$T_f$	$T_a = 25^{\circ}\text{C}$ , $C_l = 1\text{nF}$	-	35	150	ns
<b>START UP SECTION</b>						
VSTR Start-up Current	Istr	$V_{\text{str}} = 30\text{V}$ , $T_a = 25^{\circ}\text{C}$	0.5	1	1.5	mA

**Note:**

1. These parameters, although guaranteed, are not 100% tested in production.
2. It is recommended to connect  $1\text{M}\Omega$  resistor between the Latch/SS pin and GND to prevent abnormal operation of the latch protection by noise coupling.

## Typical Performance Characteristics

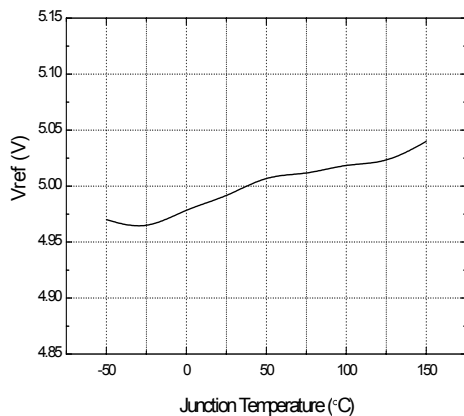

Figure 1. Trimmed Reference Voltage

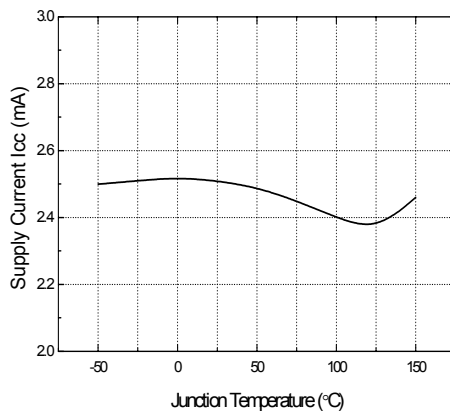

Figure 2. Supply Current

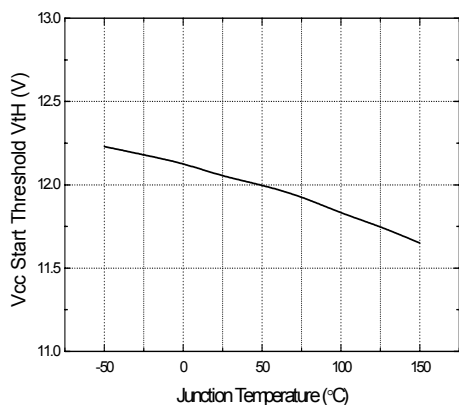

Figure 3. Vcc Start Threshold Voltage

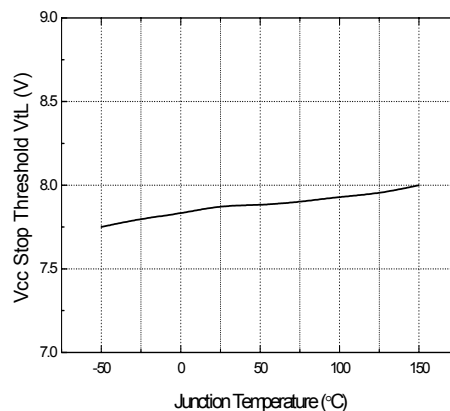

Figure 4. Vcc Stop Threshold Voltage

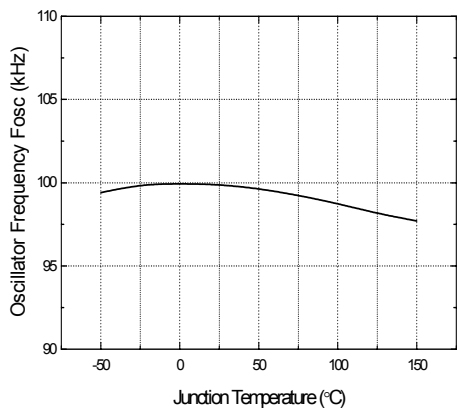

Figure 5. Oscillator Frequency

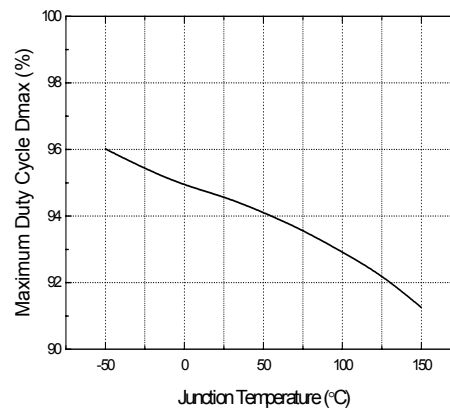

Figure 6. Maximum Duty Cycle

Typical Performance Characteristics (Continued)

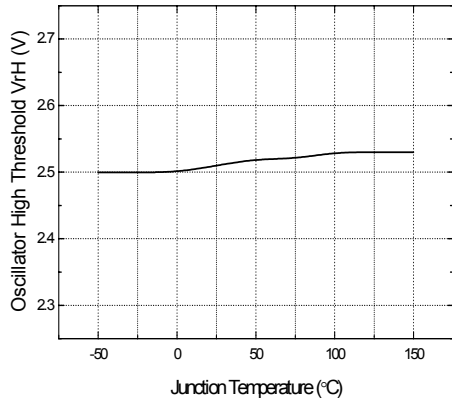

Figure 7. Oscillator High Threshold Voltage

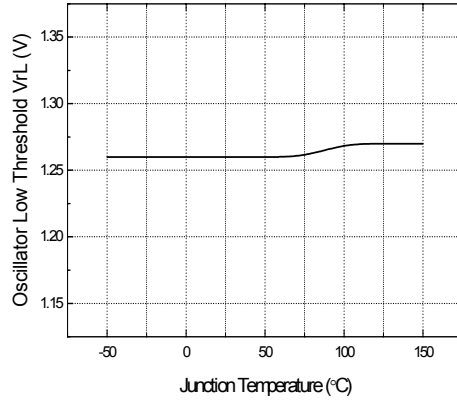

Figure 8. Oscillator Low Threshold Voltage

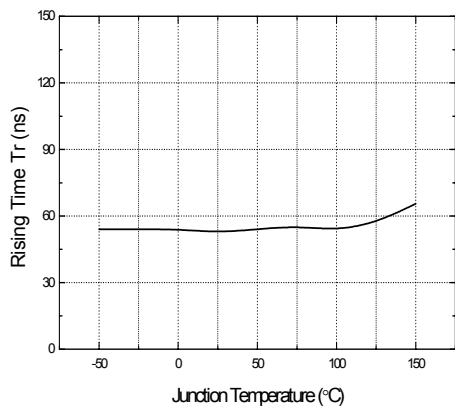

Figure 9. Output Rising Time

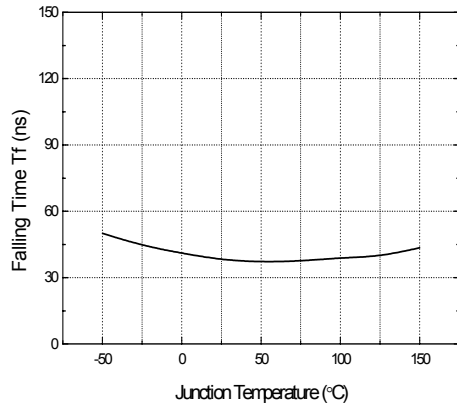

Figure 10. Output Falling Time

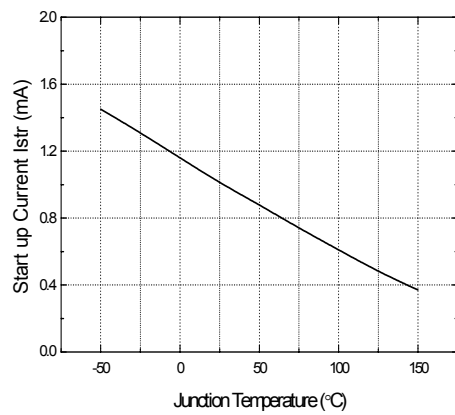

Figure 11. Start-up Current

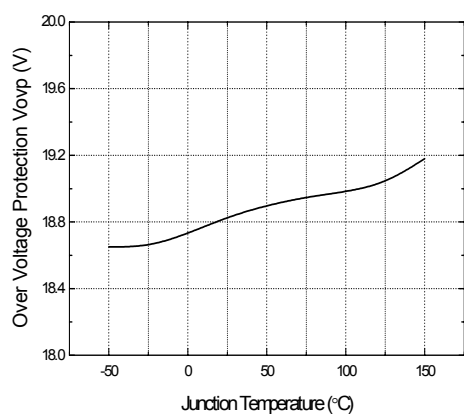

Figure 12. Over Voltage Protection Level

Typical Performance Characteristics (Continued)

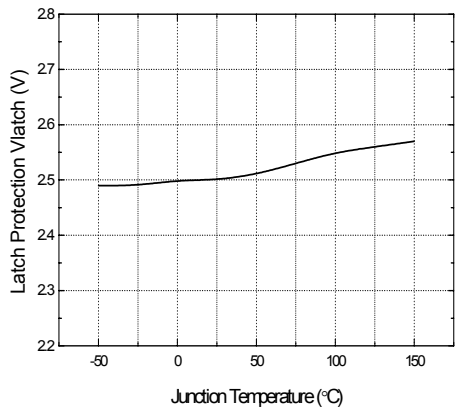

Figure 13. Latch Protection Voltage

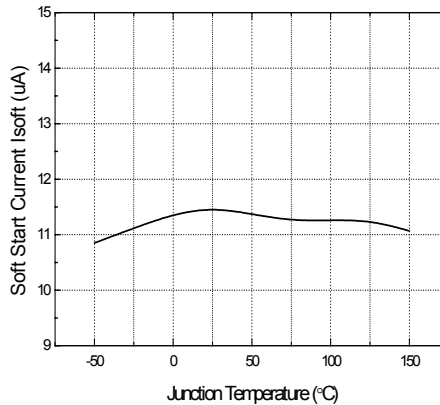

Figure 14. Soft Start Current

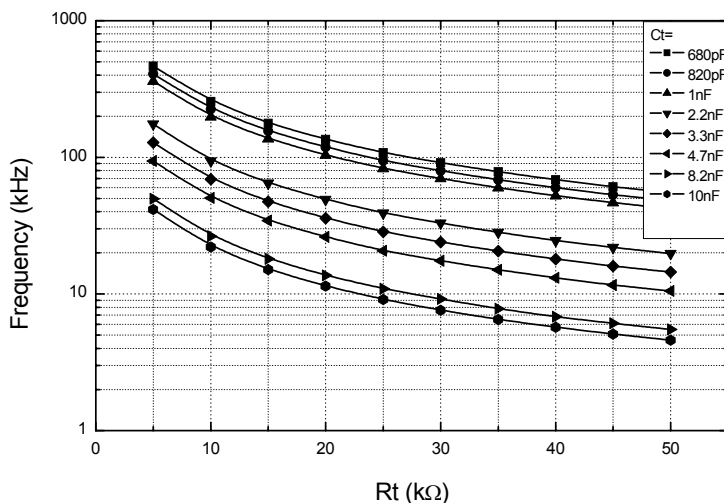
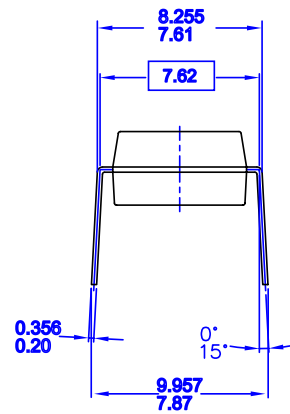
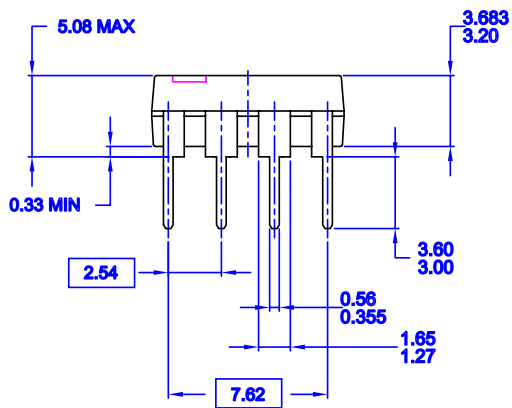
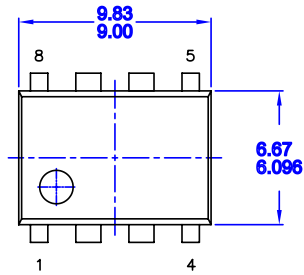

Figure 15. Oscillator Frequency Characteristic

# Mechanical Dimensions

## 8DIP



- NOTES: UNLESS OTHERWISE SPECIFIED  
 A) THIS PACKAGE CONFORMS TO JEDEC MS-001 VARIATION BA  
 B) ALL DIMENSIONS ARE IN MILLIMETERS.  
 C) DIMENSIONS ARE EXCLUSIVE OF BURRS, MOLD FLASH, AND TIE BAR EXTRUSIONS.  
 D) DIMENSIONS AND TOLERANCES PER ASME Y14.5M-1994

MKT-N08FrevB



Mechanical Dimensions (Unit: mm) (Continued)

Package

8-SOP

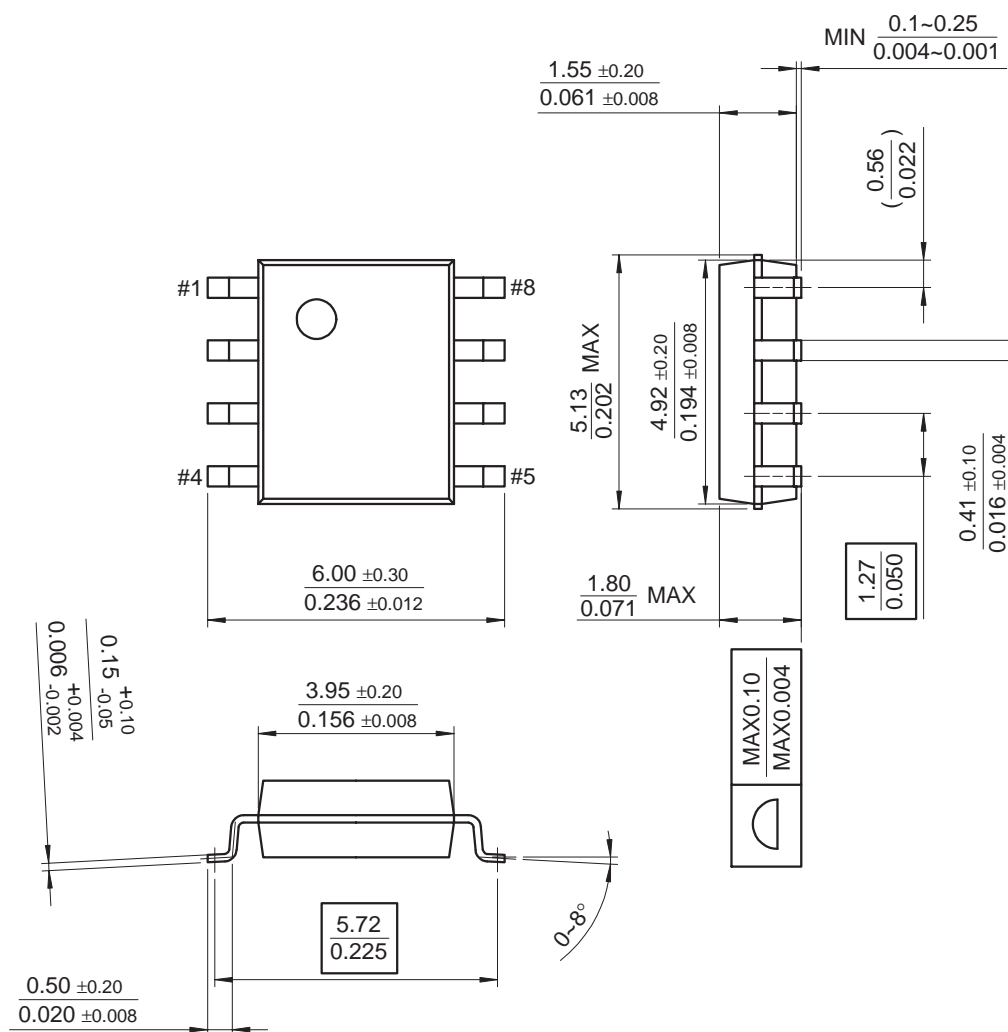

Mechanical Dimensions (Unit: mm) (Continued)

Package

10-SSOP-225

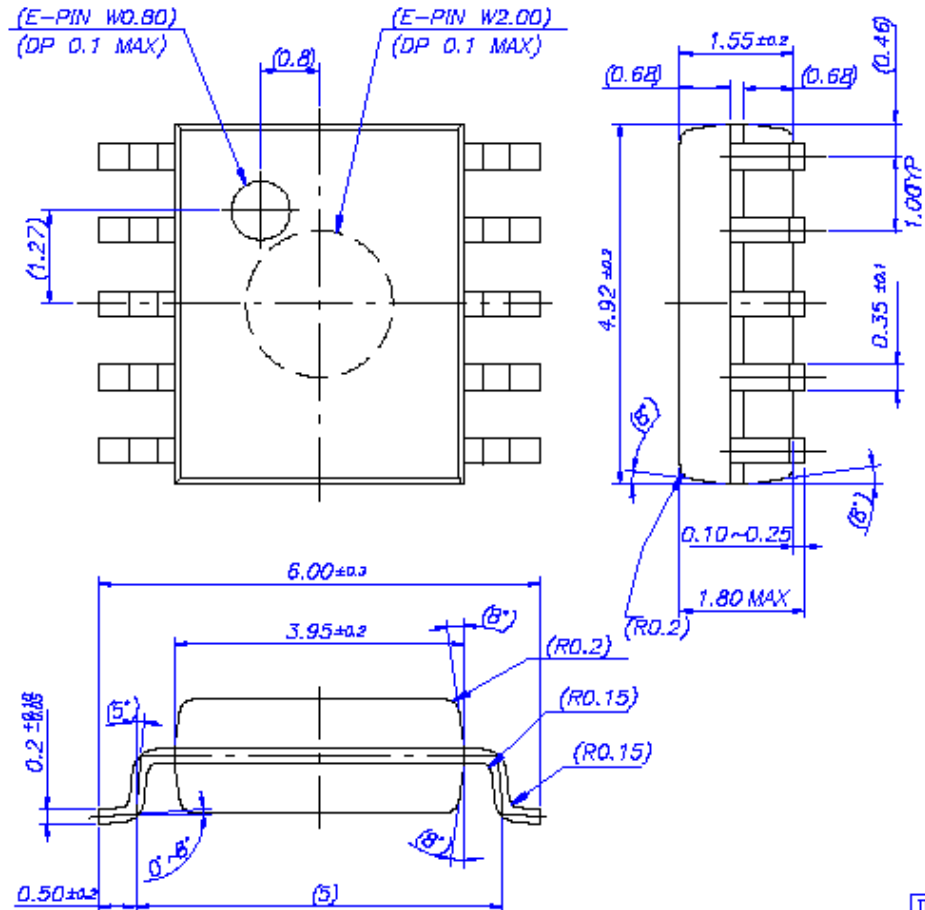

---

## Ordering Information

Device	Package	Operating Temp.
FAN7601N	8-DIP	-25°C ~ 125°C
FAN7601M	8-SOP	
FAN7601G	10-SSOP	

**DISCLAIMER**

FAIRCHILD SEMICONDUCTOR RESERVES THE RIGHT TO MAKE CHANGES WITHOUT FURTHER NOTICE TO ANY PRODUCTS HEREIN TO IMPROVE RELIABILITY, FUNCTION OR DESIGN. FAIRCHILD DOES NOT ASSUME ANY LIABILITY ARISING OUT OF THE APPLICATION OR USE OF ANY PRODUCT OR CIRCUIT DESCRIBED HEREIN; NEITHER DOES IT CONVEY ANY LICENSE UNDER ITS PATENT RIGHTS, NOR THE RIGHTS OF OTHERS.

**LIFE SUPPORT POLICY**

FAIRCHILD'S PRODUCTS ARE NOT AUTHORIZED FOR USE AS CRITICAL COMPONENTS IN LIFE SUPPORT DEVICES OR SYSTEMS WITHOUT THE EXPRESS WRITTEN APPROVAL OF THE PRESIDENT OF FAIRCHILD SEMICONDUCTOR CORPORATION. As used herein:

1. Life support devices or systems are devices or systems which, (a) are intended for surgical implant into the body, or (b) support or sustain life, and (c) whose failure to perform when properly used in accordance with instructions for use provided in the labeling, can be reasonably expected to result in a significant injury of the user.
2. A critical component in any component of a life support device or system whose failure to perform can be reasonably expected to cause the failure of the life support device or system, or to affect its safety or effectiveness.