

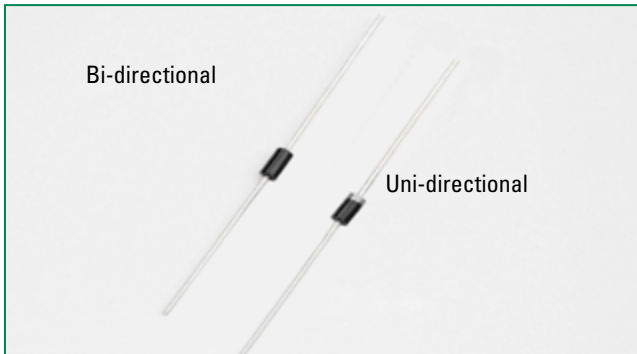

### P4KE Series



#### Agency Approvals

AGENCY	AGENCY FILE NUMBER
	E230531

#### Maximum Ratings and Thermal Characteristics (T<sub>A</sub> = 25°C unless otherwise noted)

Parameter	Symbol	Value	Unit
Peak Pulse Power Dissipation by 10/1000µs Test Waveform (Fig.2) (Note 1), (Note 4)	P <sub>PPM</sub>	400	W
Steady State Power Dissipation on Infinite Heat Sink at T <sub>L</sub> = 75°C	P <sub>D</sub>	1.5	W
Peak Forward Surge Current, 8.3ms Single Half Sine Wave Unidirectional Only (Note 2)	I <sub>FSM</sub>	60	A
Maximum Instantaneous Forward Voltage at 25A for Unidirectional Only (Note 3)	V <sub>F</sub>	3.5/5.0	V
Operating Junction and Storage Temperature Range	T <sub>J</sub> , T <sub>STG</sub>	-55 to 175	°C
Typical Thermal Resistance Junction to Lead	R <sub>θJL</sub>	60	°C/W
Typical Thermal Resistance Junction to Ambient	R <sub>θJA</sub>	100	°C/W

#### Notes:

1. Non-repetitive current pulse, per Fig. 4 and derated above T<sub>J</sub> (initial) = 25°C per Fig. 3.
2. Measured on 8.3ms single half sine wave or equivalent square wave, duty cycle = 4 per minute maximum.
3. V<sub>F</sub> < 3.5V for single die parts and V<sub>F</sub> < 5.0V for stacked-die parts.
4. The P<sub>PPM</sub> of stacked-die parts is 600W and please contact littelfuse for the detail stacked-die parts.

#### Functional Diagram

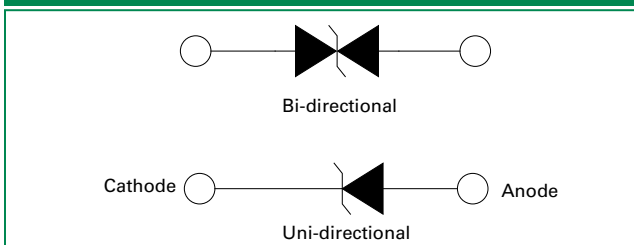

#### Description

The P4KE Series is designed specifically to protect sensitive electronic equipment from voltage transients induced by lightning and other transient voltage events.

#### Features

- 400W peak pulse capability at 10/1000µs waveform, repetition rate (duty cycles): 0.01%
- Glass passivated chip junction in DO-41 Package
- Fast response time: typically less than 1.0ps from 0 Volts to BV min
- Excellent clamping capability
- Typical failure mode is short from over-specified voltage or current
- Whisker test is conducted based on JEDEC JESD201A per its table 4a and 4c
- IEC-61000-4-2 ESD 30kV(Air), 30kV (Contact)
- ESD protection of data lines in accordance with IEC 61000-4-2
- EFT protection of data lines in accordance with IEC 61000-4-4
- Low incremental surge resistance
- Typical I<sub>R</sub> less than 1µA when V<sub>BR</sub> min > 12V
- High temperature to reflow soldering guaranteed: 260°C/40sec / 0.375"/(9.5mm) lead length, 5 lbs., (2.3kg) tension
- V<sub>BR</sub> @ T<sub>J</sub> = V<sub>BR</sub> @ 25°C x (1 + α T x (T<sub>J</sub> - 25)) (α T: Temperature Coefficient, typical value is 0.1%)
- Plastic package is flammability rated V-0 per Underwriters Laboratories
- Matte tin lead-free plated
- Halogen free and RoHS compliant
- Pb-free E3 means 2nd level interconnect is Pb-free and the terminal finish material is tin(Sn) (IPC/JEDEC J-STD-609A.01)

#### Applications

TVS devices are ideal for the protection of I/O interfaces, V<sub>CC</sub> bus and other vulnerable circuits used in telecom, computer, industrial and consumer electronic applications.

#### Additional Information



**Datasheet**



**Resources**



**Samples**

### Electrical Characteristics (T<sub>A</sub>=25°C unless otherwise noted)

Part Number (Uni)	Part Number (Bi)	Reverse Stand off Voltage V <sub>R</sub> (Volts)	Breakdown Voltage V <sub>BR</sub> @ I <sub>T</sub> (V)		Test Current I <sub>T</sub> (mA)	Maximum Clamping Voltage V <sub>C</sub> @ I <sub>pp</sub> (V)	Maximum Peak Pulse Current I <sub>pp</sub> (A)	Maximum Reverse Leakage I <sub>R</sub> @ V <sub>R</sub> (μA)	Agency Approval 
			MIN	MAX					
P4KE6.8A	P4KE6.8CA	5.80	6.45	7.14	10	10.5	39.00	1000	X
P4KE7.5A	P4KE7.5CA	6.40	7.13	7.88	10	11.3	36.30	500	X
P4KE8.2A	P4KE8.2CA	7.02	7.79	8.61	10	12.1	33.90	200	X
P4KE9.1A	P4KE9.1CA	7.78	8.65	9.55	1	13.4	30.60	50	X
P4KE10A	P4KE10CA	8.55	9.50	10.50	1	14.5	28.30	10	X
P4KE11A	P4KE11CA	9.40	10.50	11.60	1	15.6	26.30	5	X
P4KE12A	P4KE12CA	10.20	11.40	12.60	1	16.7	24.60	5	X
P4KE13A	P4KE13CA	11.10	12.40	13.70	1	18.2	22.50	1	X
P4KE15A	P4KE15CA	12.80	14.30	15.80	1	21.2	19.30	1	X
P4KE16A	P4KE16CA	13.60	15.20	16.80	1	22.5	18.20	1	X
P4KE18A	P4KE18CA	15.30	17.10	18.90	1	25.5	16.10	1	X
P4KE20A	P4KE20CA	17.10	19.00	21.00	1	27.7	14.80	1	X
P4KE22A	P4KE22CA	18.80	20.90	23.10	1	30.6	13.40	1	X
P4KE24A	P4KE24CA	20.50	22.80	25.20	1	33.2	12.30	1	X
P4KE27A	P4KE27CA	23.10	25.70	28.40	1	37.5	10.90	1	X
P4KE30A	P4KE30CA	25.60	28.50	31.50	1	41.4	9.90	1	X
P4KE33A	P4KE33CA	28.20	31.40	34.70	1	45.7	9.00	1	X
P4KE36A	P4KE36CA	30.80	34.20	37.80	1	49.9	8.20	1	X
P4KE39A	P4KE39CA	33.30	37.10	41.00	1	53.9	7.60	1	X
P4KE43A	P4KE43CA	36.80	40.90	45.20	1	59.3	6.90	1	X
P4KE47A	P4KE47CA	40.20	44.70	49.40	1	64.8	6.30	1	X
P4KE51A	P4KE51CA	43.60	48.50	53.60	1	70.1	5.80	1	X
P4KE56A	P4KE56CA	47.80	53.20	58.80	1	77.0	5.30	1	X
P4KE62A	P4KE62CA	53.00	58.90	65.10	1	85.0	4.80	1	X
P4KE68A	P4KE68CA	58.10	64.60	71.40	1	92.0	4.50	1	X
P4KE75A	P4KE75CA	64.10	71.30	78.80	1	103.0	4.00	1	X
P4KE82A	P4KE82CA	70.10	77.90	86.10	1	113.0	3.60	1	X
P4KE91A	P4KE91CA	77.80	86.50	95.50	1	125.0	3.30	1	X
P4KE100A	P4KE100CA	85.50	95.00	105.00	1	137.0	3.00	1	X
P4KE110A	P4KE110CA	94.00	105.00	116.00	1	152.0	2.70	1	X
P4KE120A	P4KE120CA	102.00	114.00	126.00	1	165.0	2.50	1	X
P4KE130A	P4KE130CA	111.00	124.00	137.00	1	179.0	2.30	1	X
P4KE150A	P4KE150CA	128.00	143.00	158.00	1	207.0	2.00	1	X
P4KE160A	P4KE160CA	136.00	152.00	168.00	1	219.0	1.90	1	X
P4KE170A	P4KE170CA	145.00	162.00	179.00	1	234.0	1.80	1	X
P4KE180A	P4KE180CA	154.00	171.00	189.00	1	246.0	1.70	1	X
P4KE200A	P4KE200CA	171.00	190.00	210.00	1	274.0	1.50	1	X
P4KE220A	P4KE220CA	185.00	209.00	231.00	1	328.0	1.30	1	X
P4KE250A	P4KE250CA	214.00	237.00	263.00	1	344.0	1.20	1	X
P4KE300A	P4KE300CA	256.00	285.00	315.00	1	414.0	1.00	1	X
P4KE350A	P4KE350CA	300.00	332.00	368.00	1	482.0	0.85	1	X
P4KE400A	P4KE400CA	342.00	380.00	420.00	1	548.0	0.75	1	X
P4KE440A	P4KE440CA	376.00	418.00	462.00	1	602.0	0.68	1	X
P4KE480A	P4KE480CA	408.00	456.00	504.00	1	658.0	0.61	1	X
P4KE510A	P4KE510CA	434.00	485.00	535.00	1	698.0	0.57	1	X
P4KE530A	P4KE530CA	451.00	503.50	556.50	1	725.0	0.55	1	X
P4KE540A	P4KE540CA	460.00	513.00	567.00	1	740.0	0.54	1	X
P4KE550A	P4KE550CA	468.00	522.50	577.50	1	760.0	0.52	1	X

For bidirectional type having V<sub>R</sub> of 10 volts and less, the I<sub>R</sub> limit is double.

For parts without A, the V<sub>BR</sub> is ± 10% and V<sub>C</sub> is 5% higher than with A parts

### I-V Curve Characteristics

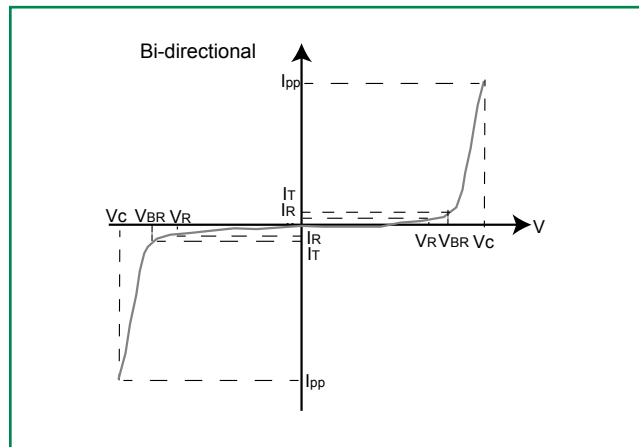
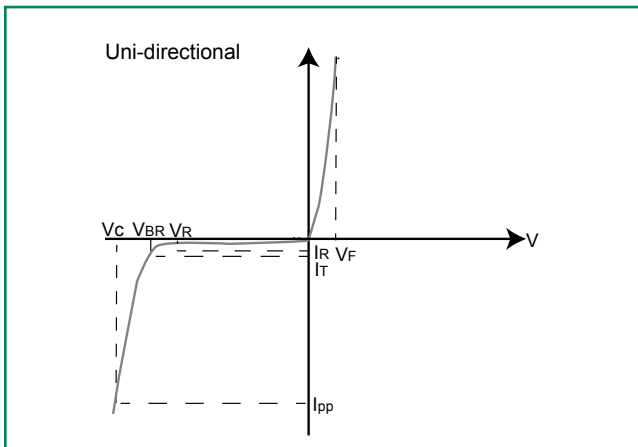

**$P_{PPM}$  Peak Pulse Power Dissipation** – Max power dissipation

**$V_R$  Stand-off Voltage** – Maximum voltage that can be applied to the TVS without operation

**$V_{BR}$  Breakdown Voltage** – Maximum voltage that flows though the TVS at a specified test current ( $I_R$ )

**$V_C$  Clamping Voltage** – Peak voltage measured across the TVS at a specified  $I_{ppm}$  (peak impulse current)

**$I_R$  Reverse Leakage Current** – Current measured at  $V_R$

**$V_F$  Forward Voltage Drop for Uni-directional**

### Ratings and Characteristic Curves ( $T_A=25^\circ\text{C}$ unless otherwise noted)

Figure 1 - TVS Transients Clamping Waveform

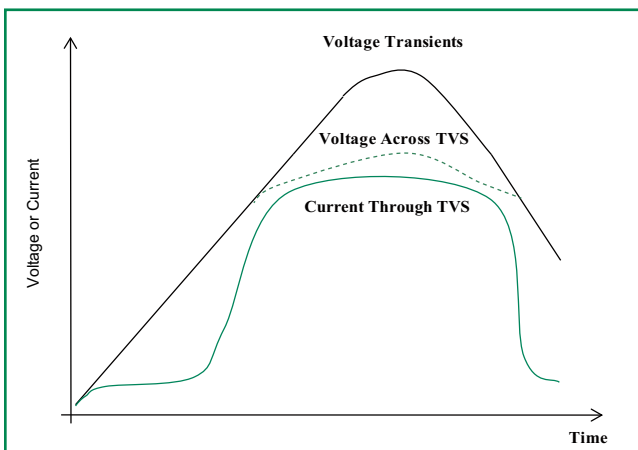
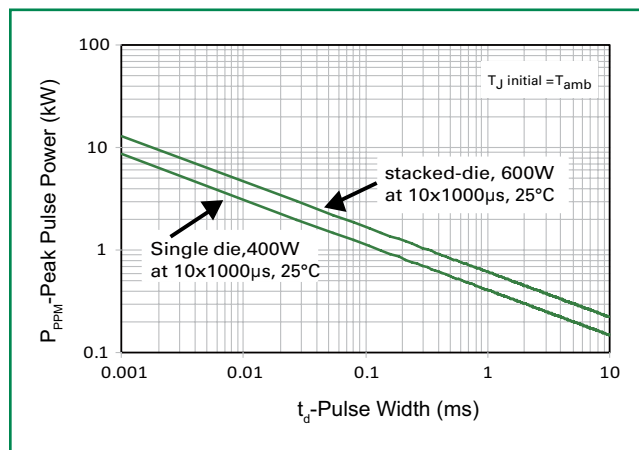

Figure 2 - Peak Pulse Power Rating Curve



continues on next page.

### Ratings and Characteristic Curves ( $T_A=25^\circ\text{C}$ unless otherwise noted) (Continued)

**Figure 3 - Peak Pulse Power Derating Curve**

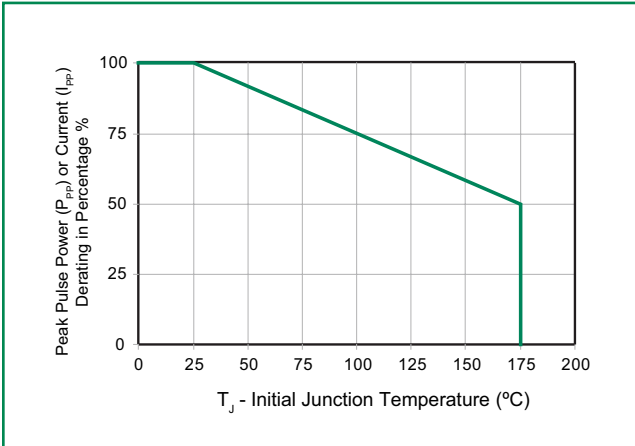

**Figure 4 - Pulse Waveform**

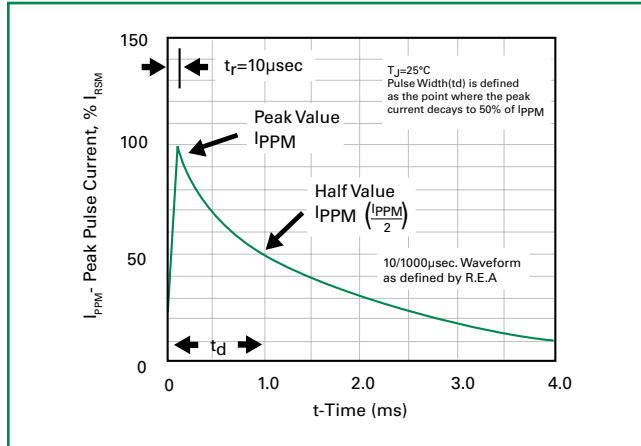

**Figure 5 - Typical Junction Capacitance**

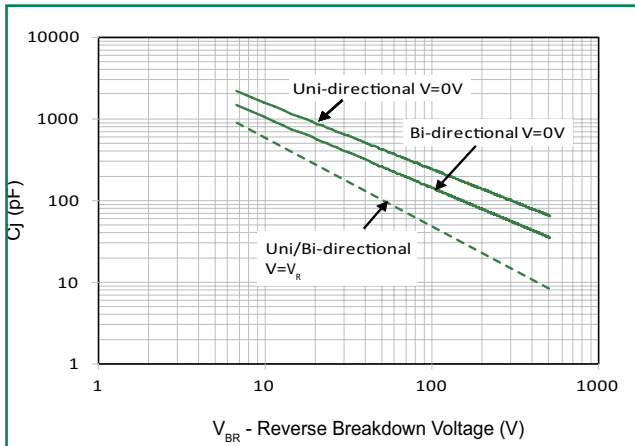

**Figure 6 - Typical Transient Thermal Impedance**

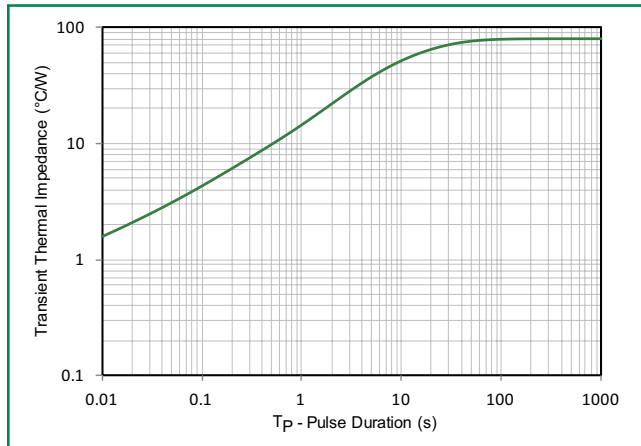

**Figure 7 - Maximum Non-Repetitive Forward Surge Current Uni-Directional Only**

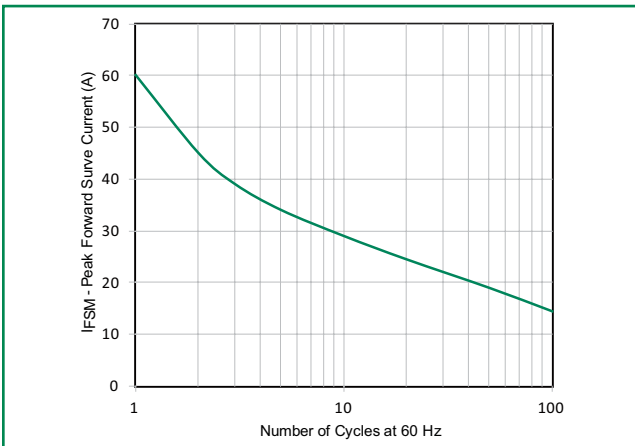

**Figure 8 - Peak Forward Voltage Drop vs Peak Forward Current (Typical Values)**

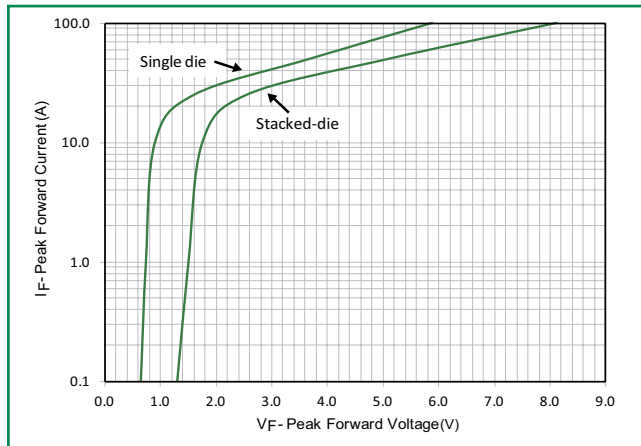

# Transient Voltage Suppression Diodes

Axial Leaded – 400W > P4KE series

## Soldering Parameters

Reflow Condition		Lead-free assembly
Pre Heat	- Temperature Min ( $T_{s(min)}$ )	150°C
	- Temperature Max ( $T_{s(max)}$ )	200°C
	- Time (min to max) ( $t_s$ )	60 – 180 secs
Average ramp up rate (Liquidus Temp ( $T_A$ ) to peak)		3°C/second max
$T_{s(max)}$ to $T_A$ - Ramp-up Rate		3°C/second max
Reflow	- Temperature ( $T_A$ ) (Liquidus)	217°C
	- Time (min to max) ( $t_s$ )	60 – 150 seconds
Peak Temperature ( $T_p$ )		260 <sup>+0/-5</sup> °C
Time within 5°C of actual peak Temperature ( $t_p$ )		20 – 40 seconds
Ramp-down Rate		6°C/second max
Time 25°C to peak Temperature ( $T_p$ )		8 minutes Max.
Do not exceed		260°C

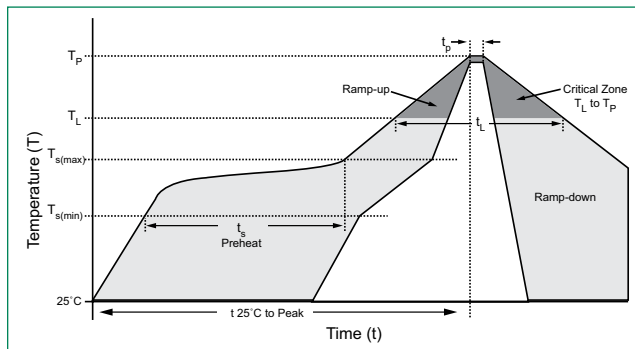

## Flow/Wave Soldering (Solder Dipping)

<b>Peak Temperature :</b>	260°C
<b>Dipping Time :</b>	5 seconds
<b>Soldering :</b>	1 time

## Physical Specifications

<b>Weight</b>	0.012oz., 0.3g
<b>Case</b>	JEDEC DO-204AL (DO-41) molded plastic body over passivated junction.
<b>Polarity</b>	Color band denotes the cathode except Bipolar.
<b>Terminal</b>	Matte Tin axial leads, solderable per JESD22-B102.

## Environmental Specifications

<b>High Temp. Storage</b>	JESD22-A103
<b>HTRB</b>	JESD22-A108
<b>Temperature Cycling</b>	JESD22-A104
<b>H3TRB</b>	JESD22-A101
<b>RSH</b>	JESD22-B106

## Dimensions

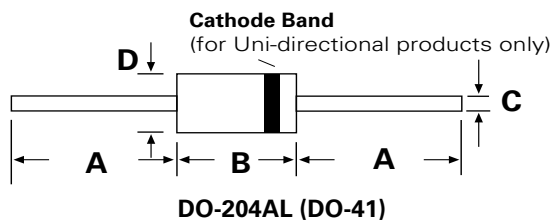

Dimensions	Inches		Millimeters	
	Min	Max	Min	Max
A	1.000	-	25.40	-
B	0.160	0.205	4.10	5.20
C	0.028	0.034	0.71	0.86
D	0.080	0.107	2.00	2.70

### Part Numbering System

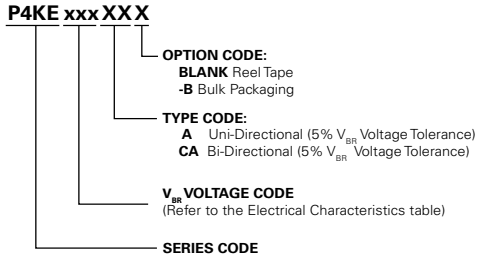

### Part Marking System

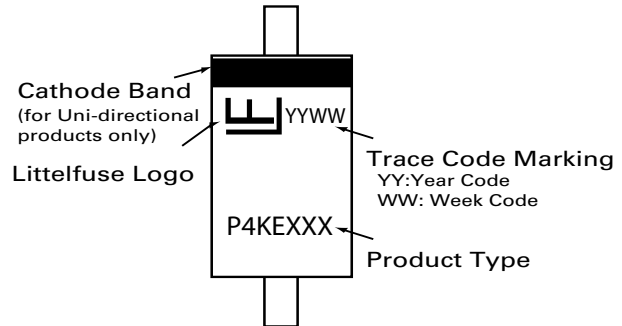

### Packaging

Part Number	Component Package	Quantity	Packaging Option	Packaging Specification
P4KExxxXX	DO-204AL	5000	Tape & Reel	EIA STD RS-296
P4KExxxXX-B	DO-204AL	500	BOX	Littelfuse Spec.

### Tape and Reel Specification

