

MAX9814

Microphone Amplifier with AGC and Low-Noise Microphone Bias

General Description

The MAX9814 is a low-cost, high-quality microphone amplifier with automatic gain control (AGC) and low-noise microphone bias. The device features a low-noise preamplifier, variable gain amplifier (VGA), output amplifier, microphone-bias-voltage generator, and AGC control circuitry.

The low-noise preamplifier has a fixed 12dB gain, while the VGA gain automatically adjusts from 20dB to 0dB, depending on the output voltage and the AGC threshold. The output amplifier offers selectable gains of 8dB, 18dB, and 28dB. With no compression, the cascade of the amplifiers results in an overall gain of 40dB, 50dB, or 60dB. A trilevel digital input programs the output amplifier gain. An external resistive divider controls the AGC threshold and a single capacitor programs the attack/release times. A trilevel digital input programs the ratio of attack-to-release time. The hold time of the AGC is fixed at 30ms. The low-noise microphone-bias-voltage generator can bias most electret microphones.

The MAX9814 is available in the space-saving, 14-pin TDFN package. This device is specified over the -40°C to +85°C extended temperature range.

Applications

- Digital Still Cameras
- Digital Video Cameras
- PDAs
- Bluetooth Headsets
- Entertainment Systems (e.g., Karaoke)
- Two-Way Communicators
- High-Quality Portable Recorders
- IP Phones/Telephone Conferencing

Features

- Automatic Gain Control (AGC)
- Three Gain Settings (40dB, 50dB, 60dB)
- Programmable Attack Time
- Programmable Attack and Release Ratio
- 2.7V to 5.5V Supply Voltage Range
- Low Input-Referred Noise Density of $30\text{nV}/\sqrt{\text{Hz}}$
- Low THD: 0.04% (typ)
- Low-Power Shutdown Mode
- Internal Low-Noise Microphone Bias, 2V
- Available in the Space-Saving, 14-Pin TDFN (3mm x 3mm) Package
- -40°C to +85°C Extended Temperature Range

Ordering Information appears at end of data sheet.

Simplified Block Diagram

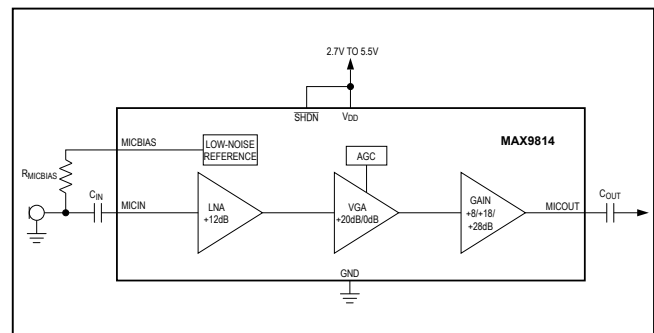

Absolute Maximum Ratings

V_{DD} to GND-0.3V to +6V
 All Other Pins to GND -0.3V to (V_{DD} + 0.3V)
 Output Short-Circuit Duration Continuous
 Continuous Current (MICOUT, MICBIAS) ±100mA
 All Other Pins ±20mA

Continuous Power Dissipation (T_A = +70°C)
 14-Pin TDFN-EP
 (derate 16.7mW/°C above +70°C) 1481.5mW
 Operating Temperature Range -40°C to +85°C
 Junction Temperature +150°C
 Lead Temperature (soldering, 10s) +300°C
 Bump Temperature (soldering) Reflow +235°C

Stresses beyond those listed under "Absolute Maximum Ratings" may cause permanent damage to the device. These are stress ratings only, and functional operation of the device at these or any other conditions beyond those indicated in the operational sections of the specifications is not implied. Exposure to absolute maximum rating conditions for extended periods may affect device reliability.

Electrical Characteristics

(V_{DD} = 3.3V, SHDN = V_{DD}, C_{CT} = 470nF, C_{CG} = 2µF, GAIN = V_{DD}, T_A = T_{MIN} to T_{MAX}, unless otherwise specified. Typical values are at T_A = +25°C.) (Note 1)

| PARAMETER | SYMBOL | CONDITIONS | MIN | TYP | MAX | UNITS |
|--------------------------------------|----------------------|---|------|--------|------|-------------------|
| GENERAL | | | | | | |
| Operating Voltage | V _{DD} | Guaranteed by PSRR test | 2.7 | | 5.5 | V |
| Supply Current | I _{DD} | | | 3.1 | 6 | mA |
| Shutdown Supply Current | I _{SHDN} | | | 0.01 | 1 | µA |
| Input-Referred Noise Density | e _n | BW = 20kHz, all gain settings | | 30 | | nV/√Hz |
| Output Noise | | BW = 20kHz | | 430 | | µV _{RMS} |
| Signal-to-Noise Ratio | SNR | BW = 22Hz to 22kHz (500mV _{RMS} output signal) | | 61 | | dB |
| | | A-weighted | | 64 | | |
| Dynamic Range | DR | (Note 2) | | 60 | | dB |
| Total Harmonic Distortion Plus Noise | THD+N | f _{IN} = 1kHz, BW = 20Hz to 20kHz, R _L = 10kΩ, V _{TH} = 1V (threshold = 2V _{P-P}), V _{IN} = 0.5mV _{RMS} , V _{CT} = 0V | | 0.04 | | % |
| | | f _{IN} = 1kHz, BW = 20Hz to 20kHz, R _L = 10kΩ, V _{TH} = 0.1V (threshold = 200mV _{P-P}), V _{IN} = 30mV _{RMS} , V _{CT} = 2V | | 0.2 | | |
| Amplifier Input BIAS | V _{IN} | | 1.14 | 1.23 | 1.32 | V |
| Maximum Input Voltage | V _{IN_MAX} | 1% THD | | 100 | | mV _{P-P} |
| Input Impedance | Z _{IN} | | | 100 | | kΩ |
| Maximum Gain | A | GAIN = V _{DD} | 39.5 | 40 | 40.5 | dB |
| | | GAIN = GND | 49.5 | 50 | 50.6 | |
| | | GAIN = unconnected | 59.5 | 60 | 60.5 | |
| Minimum Gain | | GAIN = V _{DD} | 18.7 | 20 | 20.5 | dB |
| | | GAIN = GND | 29.0 | 30 | 30.8 | |
| | | GAIN = unconnected | 38.7 | 40 | 40.5 | |
| Maximum Output Level | V _{OUT_RMS} | 1% THD+N, V _{TH} = MICBIAS | | 0.707 | | V _{RMS} |
| Regulated Output Level | | AGC enabled, V _{TH} = 0.7V | 1.26 | 1.40 | 1.54 | V _{P-P} |
| AGC Attack Time | t _{ATTACK} | C _{CT} = 470nF (Note 3) | | 1.1 | | ms |
| Attack/Release Ratio | A/R | A/R = GND | | 1:500 | | ms/ms |
| | | A/R = V _{DD} | | 1:2000 | | |
| | | A/R = unconnected | | 1:4000 | | |

Electrical Characteristics (continued)

($V_{DD} = 3.3V$, $\overline{SHDN} = V_{DD}$, $C_{CT} = 470nF$, $C_{CG} = 2\mu F$, $GAIN = V_{DD}$, $T_A = T_{MIN}$ to T_{MAX} , unless otherwise specified. Typical values are at $T_A = +25^\circ C$.) (Note 1)

| PARAMETER | SYMBOL | CONDITIONS | MIN | TYP | MAX | UNITS |
|---|----------------------|--|--------------------------|--------------------------|-------------------------|---------------|
| MICOUT High Output Voltage | V_{OH} | I_{OUT} sourcing 1mA | | 2.45 | | V |
| MICOUT Low Output Voltage | V_{OL} | I_{OUT} sinking 1mA | | 3 | | mV |
| MICOUT Bias | | MICOUT unconnected | 1.14 | 1.23 | 1.32 | V |
| Output Impedance | Z_{OUT} | | | 50 | | Ω |
| Minimum Resistive Load | R_{LOAD_MIN} | | | 5 | | k Ω |
| Maximum Capacitive Drive | C_{LOAD_MAX} | | | 200 | | pF |
| Maximum Output Current | I_{OUT_MAX} | 1% THD, $R_L = 500\Omega$ | | 1 | 2 | mA |
| Output Short-Circuit Current | I_{SC} | | 3 | 8 | | mA |
| Power-Supply Rejection Ratio | PSRR | AGC mode; $V_{DD} = 2.7V$ to $5.5V$ (Note 4) | 35 | 50 | | dB |
| | | $f = 217Hz$, $V_{RIPPLE} = 100mV_{P-P}$ (Note 5) | | 55 | | |
| | | $f = 1kHz$, $V_{RIPPLE} = 100mV_{P-P}$ (Note 5) | | 52.5 | | |
| | | $f = 10kHz$, $V_{RIPPLE} = 100mV_{P-P}$ (Note 5) | | 43 | | |
| MICROPHONE BIAS | | | | | | |
| Microphone Bias Voltage | $V_{MICBIAS}$ | $I_{MICBIAS} = 0.5mA$ | 1.84 | 2.0 | 2.18 | V |
| Output Resistance | $R_{MICBIAS}$ | $I_{MICBIAS} = 1mA$ | | 1 | | Ω |
| Output Noise Voltage | $V_{MICBIAS_NOISE}$ | $I_{MICBIAS} = 0.5mA$, BW = 22Hz to 22kHz | | 5.5 | | μV_{RMS} |
| Power-Supply Rejection Ratio | PSRR | DC, $V_{DD} = 2.7V$ to $5.5V$ | 70 | 80 | | dB |
| | | $I_{MICBIAS} = 0.5mA$, $V_{RIPPLE} = 100mV_{P-P}$, $f_{IN} = 1kHz$ | | 71 | | |
| TRILEVEL INPUTS (A/R, GAIN) | | | | | | |
| Trilevel Input Leakage Current | | A/R or GAIN = V_{DD} | $0.5V_{DD} / 180k\Omega$ | $0.5V_{DD} / 100k\Omega$ | $0.5V_{DD} / 50k\Omega$ | mA |
| | | A/R or GAIN = GND | $0.5V_{DD} / 180k\Omega$ | $0.5V_{DD} / 100k\Omega$ | $0.5V_{DD} / 50k\Omega$ | |
| Input High Voltage | V_{IH} | | $V_{DD} \times 0.7$ | | | V |
| Input Low Voltage | V_{IL} | | $V_{DD} \times 0.3$ | | | V |
| Shutdown Enable Time | t_{ON} | | | 60 | | ms |
| Shutdown Disable Time | t_{OFF} | | | 40 | | ms |
| DIGITAL INPUT (\overline{SHDN}) | | | | | | |
| \overline{SHDN} Input Leakage Current | | | -1 | | +1 | μA |
| Input High Voltage | V_{IH} | | 1.3 | | | V |
| Input Low Voltage | V_{IL} | | 0.5 | | | V |
| AGC THRESHOLD INPUT (TH) | | | | | | |
| TH Input Leakage Current | | | -1 | | +1 | μA |

Note 1: Devices are production tested at $T_A = +25^\circ C$. Limits over temperature are guaranteed by design.

Note 2: Dynamic range is calculated using the EIAJ method. The input is applied at -60dBFS ($0.707\mu V_{RMS}$), $f_{IN} = 1kHz$.

Note 3: Attack time measured as time from AGC trigger to gain reaching 90% of its final value.

Note 4: CG is connected to an external DC voltage source, and adjusted until $V_{MICOUT} = 1.23V$.

Note 5: CG connected to GND with $2.2\mu F$.

Typical Operating Characteristics

($V_{DD} = 5V$, $C_{CT} = 470nF$, $C_{CG} = 2.2\mu F$, $V_{TH} = V_{MICBIAS} \times 0.4$, $GAIN = V_{DD}$ (40dB), AGC disabled, no load, $R_L = 10k\Omega$, $C_{OUT} = 1\mu F$, $T_A = +25^\circ C$, unless otherwise noted.)

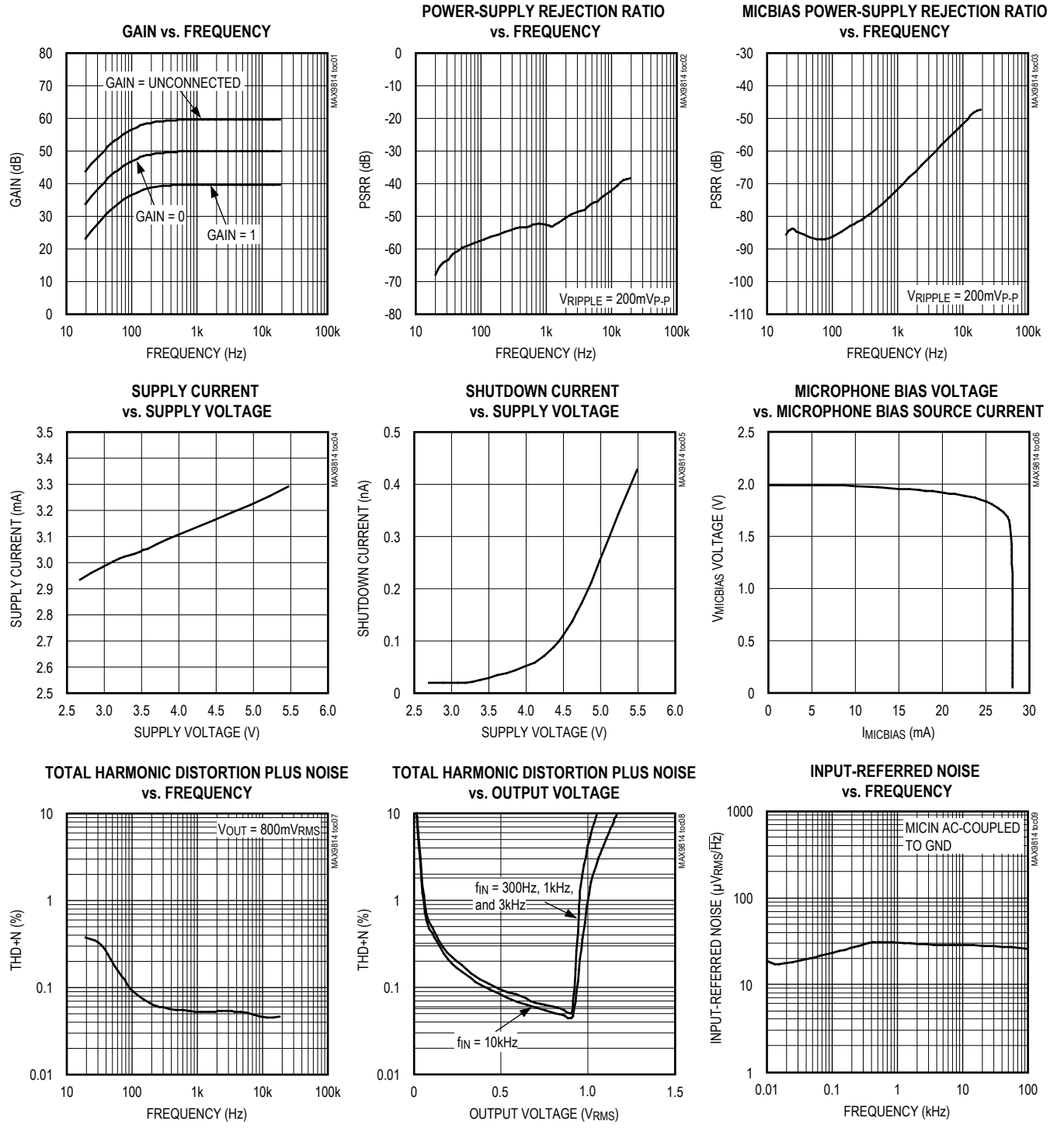

Typical Operating Characteristics (continued)

($V_{DD} = 5V$, $C_{CT} = 470nF$, $C_{CG} = 2.2\mu F$, $V_{TH} = V_{MICBIAS} \times 0.4$, $GAIN = V_{DD}$ (40dB), AGC disabled, no load, $R_L = 10k\Omega$, $C_{OUT} = 1\mu F$, $T_A = +25^\circ C$, unless otherwise noted.)

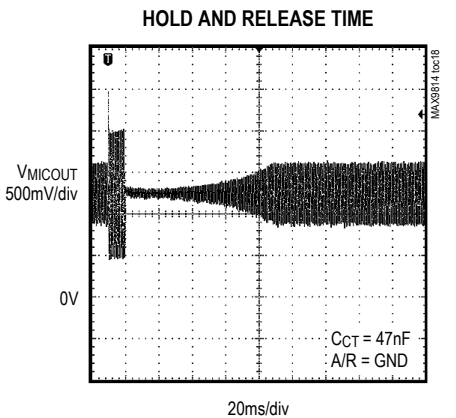
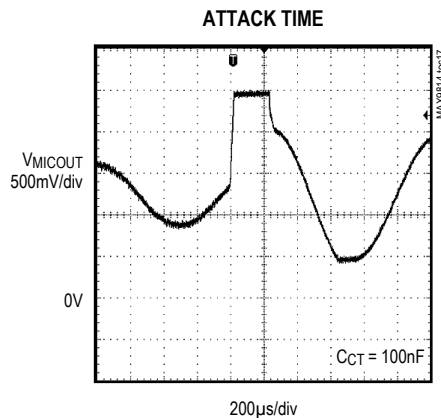
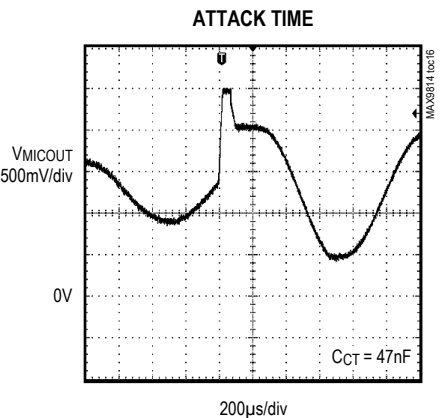
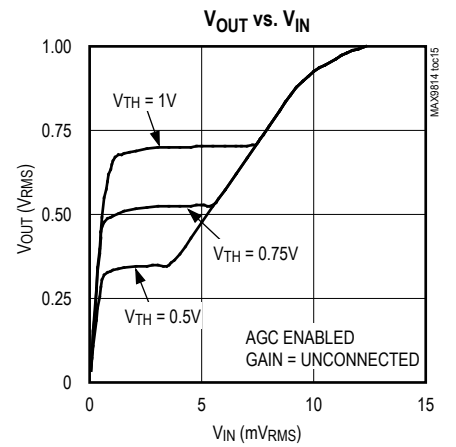
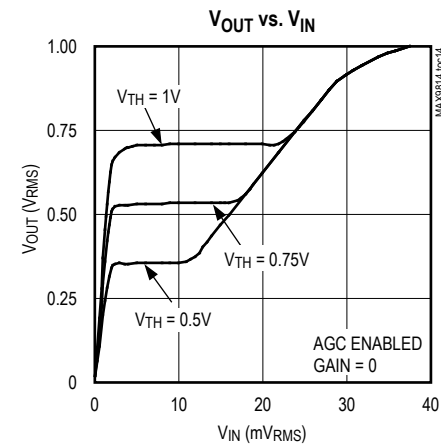
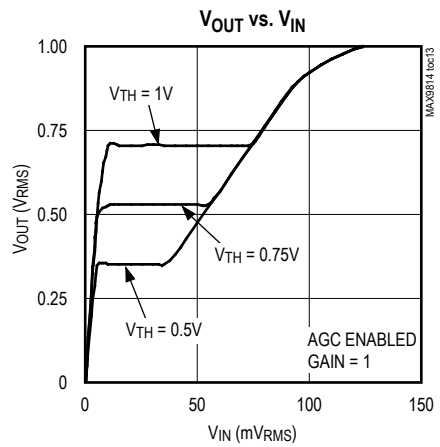
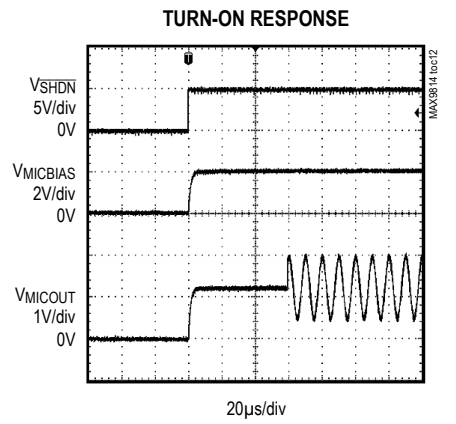
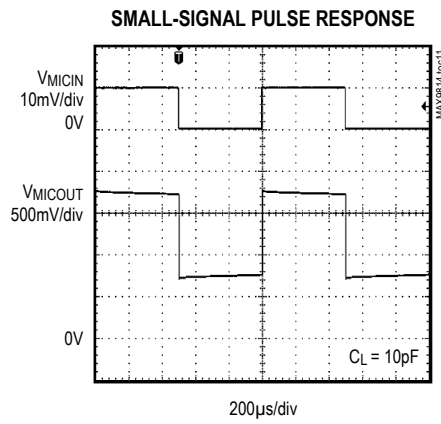
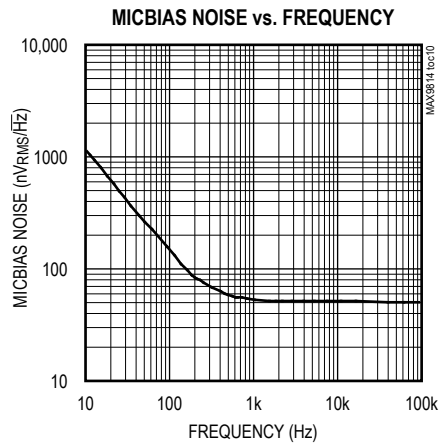

Typical Operating Characteristics (continued)

($V_{DD} = 5V$, $C_{CT} = 470nF$, $C_{CG} = 2.2\mu F$, $V_{TH} = V_{MICBIAS} \times 0.4$, $GAIN = V_{DD}$ (40dB), AGC disabled, no load, $R_L = 10k\Omega$, $C_{OUT} = 1\mu F$, $T_A = +25^\circ C$, unless otherwise noted.)

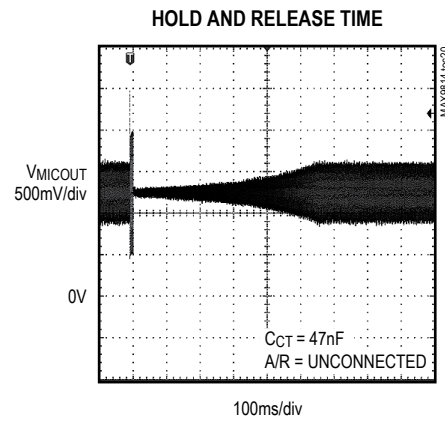
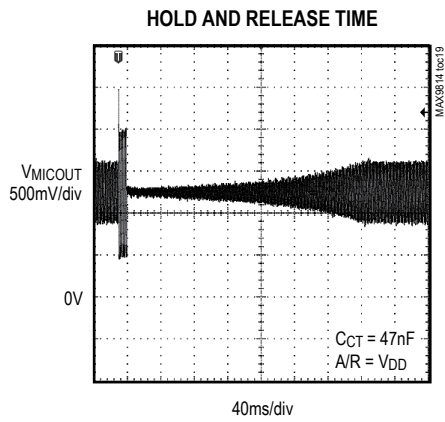

Pin Configuration

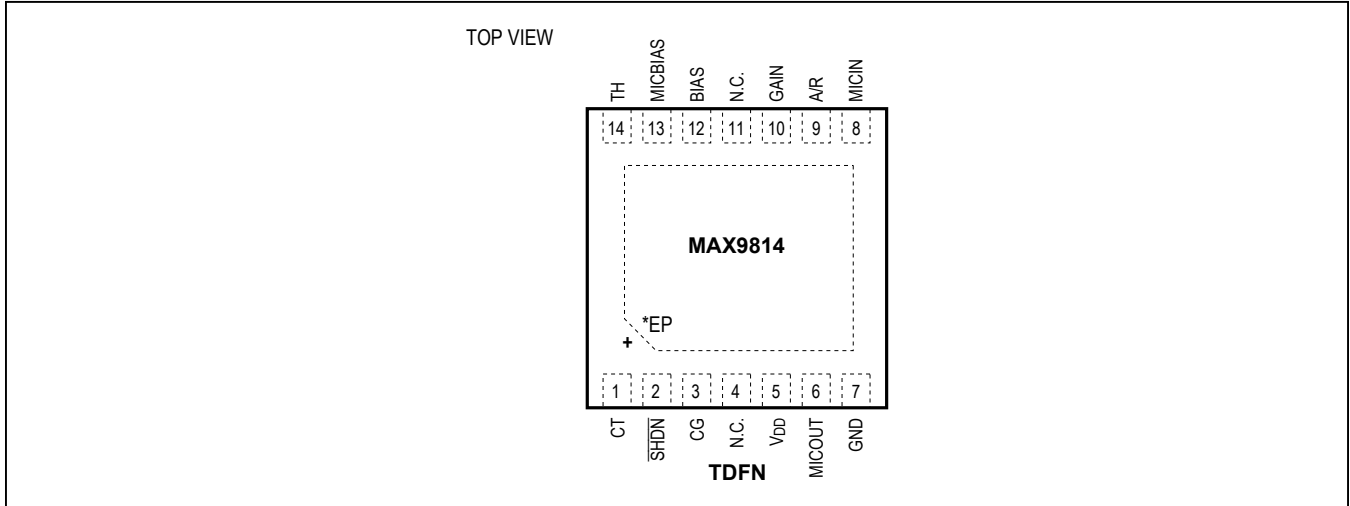

Pin Description

| PIN TDFN | NAME | FUNCTION |
|-------------|-----------------|---|
| 1 | CT | Timing Capacitor Connection. Connect a capacitor to CT to control the Attack and Release times of the AGC. |
| 2 | SHDN | Active-Low Shutdown Control |
| 3 | CG | Amplifier DC Offset Adjust. Connect a 2.2µF capacitor to GND to ensure zero offset at the output. |
| 4, 11 | N.C. | No Connection. Connect to GND. |
| 5 | V _{DD} | Power Supply. Bypass to GND with a 1µF capacitor. |
| 6 | MICOUT | Amplifier Output |
| 7 | GND | Ground |
| 8 | MICIN | Microphone Noninverting Input |
| 9 | A/R | Trilevel Attack and Release Ratio Select. Controls the ratio of attack time to release time for the AGC circuit. A/R = GND: Attack/Release Ratio is 1:500 A/R = V _{DD} : Attack/Release Ratio is 1:2000 A/R = Unconnected: Attack/Release Ratio is 1:4000 |
| 10 | GAIN | Trilevel Amplifier Gain Control. GAIN = V _{DD} , gain set to 40dB. GAIN = GND, gain set to 50dB. GAIN = Unconnected, uncompressed gain set to 60dB. |
| 12 | BIAS | Amplifier Bias. Bypass to GND with a 0.47µF capacitor. |
| 13 | MICBIAS | Microphone Bias Output |
| 14 | TH | AGC Threshold Control. TH voltage sets gain control threshold. Connect TH to MICBIAS to disable the AGC. |
| — | EP | Exposed Pad. Connect the TDFN EP to GND. |

Detailed Description

The MAX9814 is a low-cost, high-quality microphone amplifier with automatic gain control (AGC) and a low-noise microphone bias. The MAX9814 consists of several distinct circuits: a low-noise preamplifier, a variable gain amplifier (VGA), an output amplifier, a microphone-bias-voltage generator, and AGC control circuitry.

An internal microphone bias voltage generator provides a 2V bias that is suitable for most electret condenser microphones. The MAX9814 amplifies the input in three distinct stages. In the first stage, the input is buffered and amplified through the low-noise preamplifier with a gain of 12dB. The second stage consists of the VGA controlled by the AGC. The VGA/AGC combination is capable of varying the gain from 20dB to 0dB. The output amplifier is the final stage in which a fixed gain of 8dB, 18dB, 20dB is programmed through a single trilevel logic input. With no compression from the AGC, the MAX9814 is capable of providing 40dB, 50dB, or 60dB gain.

Automatic Gain Control (AGC)

A device without AGC experiences clipping at the output when too much gain is applied to the input. AGC prevents clipping at the output when too much gain is applied to the input, eliminating output clipping. Figure 1 shows a comparison of an over-gained microphone input with and without AGC.

The MAX9814’s AGC controls the gain by first detecting that the output voltage has exceeded a preset limit. The microphone amplifier gain is then reduced with a selectable time constant to correct for the excessive output-voltage amplitude. This process is known as the attack time. When the output signal subsequently lowers in amplitude, the gain is held at the reduced state for a short period before slowly increasing to the normal value. This process is known as the hold and release time. The speed at which the amplifiers adjust to changing input signals is set by the external timing capacitor C_{CT} and the voltage applied to A/R. The AGC threshold can be set by adjusting V_{TH} . Gain reduction is a function of input signal amplitude with a maximum AGC attenuation of 20dB. Figure 2 shows the effect of an input burst exceeding the preset limit, output attack, hold and release times.

If the attack-and-release times are configured to respond too fast, audible artifacts often described as “pumping” or “breathing” can occur as the gain is rapidly adjusted to follow the dynamics of the signal. For best results, adjust the time constant of the AGC to accommodate the source material. For applications in which music CDs are the main audio source, a 160µs attack time with an 80ms release time is recommended. Music applications typically require a shorter release time than voice or movie content.

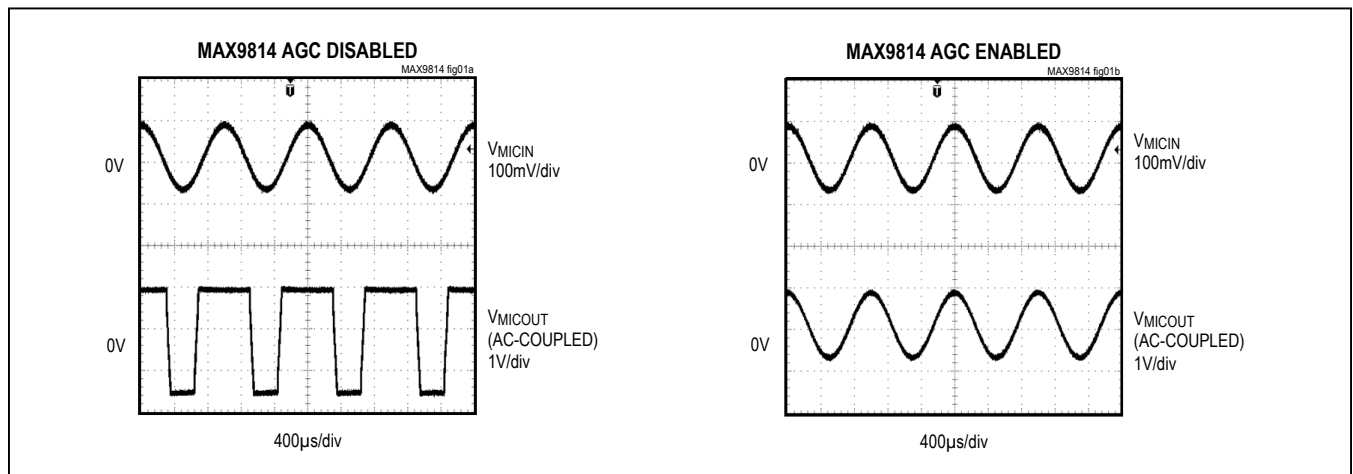

Figure 1. Microphone Input with and Without AGC

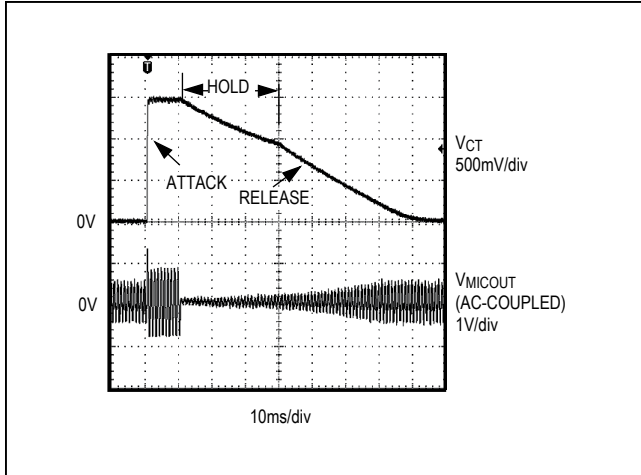

Figure 2. Input Burst Exceeding AGC Limit

Attack Time

The attack time is the time it takes for the AGC to reduce the gain after the input signal has exceeded the threshold level. The gain attenuation during the attack time is exponential, and defined as one-time constant. The time constant of the attack is given by $2400 \times C_{CT}$ seconds (where C_{CT} is the external timing capacitor):

- Use a short attack time for the AGC to react quickly to transient signals, such as snare drum beats (music) or gun shots (DVD).
- Use a longer attack time to allow the AGC to ignore short-duration peaks and only reduce the gain when a noticeable increase in loudness occurs. Short-duration peaks are not reduced, but louder passages are. This allows the louder passages to be reduced in volume, thereby maximizing output dynamic range.

Hold Time

Hold time is the delay after the signal falls below the threshold level before the release phase is initiated. Hold time is internally set to 30ms and nonadjustable. The hold time is cancelled by any signal exceeding the set threshold level, and the attack time is reinitiated.

Release Time

The release time is how long it takes for the gain to return to its normal level after the output signal has fallen below the threshold level and 30ms hold time has expired. Release time is defined as release from a 20dB gain compression to 10% of the nominal gain setting after the input signal has fallen below the TH threshold and the 30ms hold time has expired. Release time is adjustable and has a minimum of 25ms. The release time is set by picking an

attack time using C_{CT} and setting the attack-to-release time ratio by configuring A/R, as shown in Table 1:

- Use a small ratio to maximize the speed of the AGC.
- Use a large ratio to maximize the sound quality and prevent repeated excursions above the threshold from being independently adjusted by the AGC.

AGC Output Threshold

The output threshold that activates AGC is adjustable through the use of an external resistive divider. Once the divider is set, AGC reduces the gain to match the output voltage to the voltage set at the TH input.

Microphone Bias

The MAX9814 features an internal low-noise microphone bias voltage capable of driving most electret condenser microphones. The microphone bias is regulated at 2V to provide that the input signal to the low-noise preamplifier does not clip to ground.

Applications Information

Programming Attack-and-Release Times

Attack-and-release times are set by selecting the capacitance value between CT and GND, and by setting the logic state of A/R (Table 1). A/R is a trilevel logic input that sets the attack-to-release time ratio.

Table 1. Attack-and-Release Ratios

| A/R | ATTACK/RELEASE RATIO |
|-----------------|----------------------|
| GND | 1:500 |
| V _{DD} | 1:2000 |
| Unconnected | 1:4000 |

The attack-and-release times can be selected by utilizing the corresponding capacitances listed in Table 2.

Table 2. Attack-and-Release Time

| C _{CT} | t _{ATTACK} (ms) | t _{RELEASE} (ms) | | |
|-----------------|--------------------------|---------------------------|-----------------------|-------------------|
| | | A/R = GND | A/R = V _{DD} | A/R = UNCONNECTED |
| 22nF | 0.05 | 25 | 100 | 200 |
| 47nF | 0.11 | 55 | 220 | 440 |
| 68nF | 0.16 | 80 | 320 | 640 |
| 100nF | 0.24 | 120 | 480 | 960 |
| 220nF | 0.53 | 265 | 1060 | 2120 |
| 470nF | 1.1 | 550 | 2200 | 4400 |
| 680nF | 1.63 | 815 | 3260 | 6520 |
| 1μF | 2.4 | 1200 | 4800 | 9600 |

Setting the AGC Threshold

To set the output-voltage threshold at which the microphone output is clamped, an external resistor-divider must be connected from MICBIAS to ground with the output of the resistor-divider applied to TH. The voltage V_{TH} determines the peak output-voltage threshold at which the output becomes clamped. The maximum signal swing at the output is then limited to two times V_{TH} and remains at that level until the amplitude of the input signal is reduced. To disable AGC, connect TH to MICBIAS.

Microphone Bias Resistor

MICBIAS is capable of sourcing 20mA. Select a value for $R_{MICBIAS}$ that provides the desired bias current for the electret microphone. A value of 2.2k Ω is usually sufficient for a microphone of typical sensitivity. Consult the microphone data sheet for the recommended bias resistor.

Bias Capacitor

The BIAS output of the MAX9814 is internally buffered and provides a low-noise bias. Bypass BIAS with a 470nF capacitor to ground.

Input Capacitor

The input AC-coupling capacitor (C_{IN}) and the input resistance (R_{IN}) to the microphone amplifier form a high-pass filter that removes any DC bias from an input signal (see the *Typical Application Circuit/Functional Diagram*). C_{IN} prevents any DC components from the input-signal source from appearing at the amplifier outputs. The -3dB point of the highpass filter, assuming zero source impedance due to the input signal source, is given by:

$$f_{-3dB_IN} = \frac{1}{2\pi \times R_{IN} \times C_{IN}}$$

Choose C_{IN} such that f_{-3dB_IN} is well below the lowest frequency of interest. Setting f_{-3dB_IN} too high affects the amplifier's low-frequency response. Use capacitors with low-voltage coefficient dielectrics. Aluminum electrolytic, tantalum, or film dielectric capacitors are good choices for AC-coupling capacitors. Capacitors with high-voltage coefficients, such as ceramics (non-C0G dielectrics), can result in increased distortion at low frequencies.

Output Capacitor

The output of the MAX9814 is biased at 1.23V. To eliminate the DC offset, an AC-coupling capacitor (C_{OUT}) must be used. Depending on the input resistance (R_L) of the following stage, C_{OUT} and R_L effectively form a high-pass filter. The -3dB point of the highpass filter, assuming zero output impedance, is given by:

$$f_{-3dB_OUT} = \frac{1}{2\pi \times R_L \times C_{OUT}}$$

Shutdown

The MAX9814 features a low-power shutdown mode. When \overline{SHDN} goes low, the supply current drops to 0.01 μ A, the output enters a high-impedance state, and the bias current to the microphone is switched off. Driving \overline{SHDN} high enables the amplifier. Do not leave \overline{SHDN} unconnected.

Power-Supply Bypassing and PCB Layout

Bypass the power supply with a 0.1 μ F capacitor to ground. Reduce stray capacitance by minimizing trace lengths and place external components as close to the device as possible. Surface-mount components are recommended. In systems where analog and digital grounds are available, connect the MAX9814 to analog ground.

Typical Application Circuit/Functional Diagram

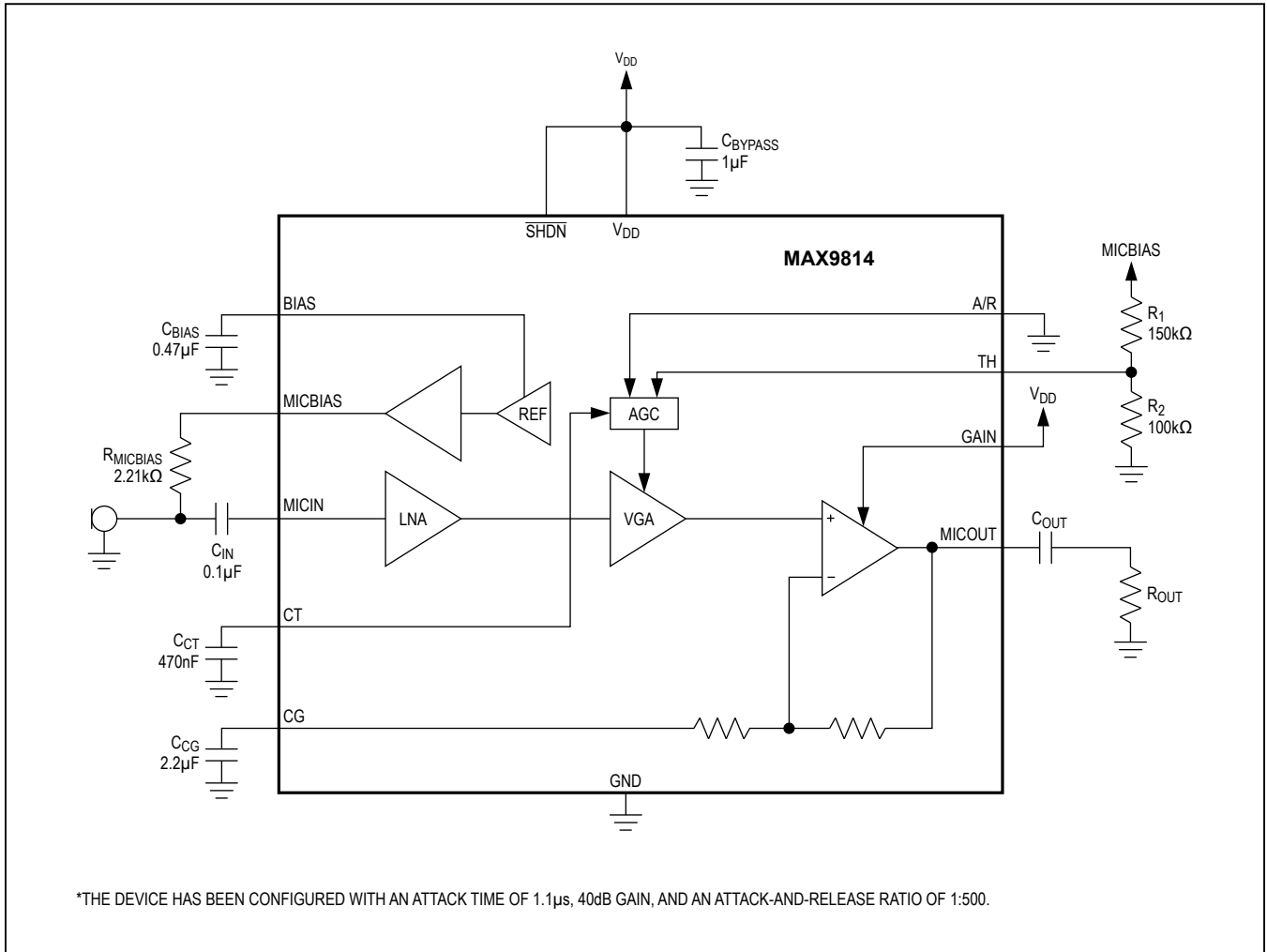

Ordering Information

| PART | TEMP RANGE | PIN-PACKAGE |
|------------------|----------------|-------------|
| MAX9814ETD+T | -40°C to +85°C | 14 TDFN-EP* |
| MAX9814ETD/V+T** | -40°C to +85°C | 14 TDFN-EP* |

+Denotes a lead(Pb)-free/RoHS-compliant package.

T = Tape and reel.

*EP = Exposed pad.

/V denotes an automotive qualified part.

**Future product—contact factory for availability.

Chip Information

PROCESS: BiCMOS

Package Information

For the latest package outline information and land patterns (footprints), go to www.maximintegrated.com/packages. Note that a “+”, “#”, or “-” in the package code indicates RoHS status only. Package drawings may show a different suffix character, but the drawing pertains to the package regardless of RoHS status.

| PACKAGE TYPE | PACKAGE CODE | OUTLINE NO. | LAND PATTERN NO. |
|--------------|--------------|-------------------------|-------------------------|
| 14 TDFN-EP | T1433+2 | 21-0137 | 90-0062 |

Revision History

| REVISION NUMBER | REVISION DATE | DESCRIPTION | PAGES CHANGED |
|-----------------|---------------|---|-----------------|
| 0 | 3/07 | Initial release | — |
| 1 | 2/09 | Updated <i>Ordering Information</i> , <i>Absolute Maximum Ratings</i> , <i>Pin Description</i> , and <i>Pin Configuration</i> sections to include EP for TDFN package | 1, 2, 6, 11 |
| 2 | 6/09 | Removed UCSP package | 1, 2, 6, 11, 12 |
| 3 | 8/16 | Updated and moved <i>Ordering Information</i> and <i>Package Information</i> tables | 1, 12 |

For pricing, delivery, and ordering information, please contact Maxim Direct at 1-888-629-4642, or visit Maxim Integrated's website at www.maximintegrated.com.

Maxim Integrated cannot assume responsibility for use of any circuitry other than circuitry entirely embodied in a Maxim Integrated product. No circuit patent licenses are implied. Maxim Integrated reserves the right to change the circuitry and specifications without notice at any time. The parametric values (min and max limits) shown in the Electrical Characteristics table are guaranteed. Other parametric values quoted in this data sheet are provided for guidance.