



Photocoupler
Product Data Sheet
MOC3083 SERIES

Spec No. :DS70-2001-027
Effective Date: 05/03/2019
Revision: F

LITE-ON DCC

RELEASE

BNS-OD-FC001/A4

Photocoupler MOC308X series

1. DESCRIPTION

1.1 Features

- Isolation voltage between input and output V_{iso} : 5,000V_{rms}
- 6pin DIP zero-cross photocoupler, triac driver output
- High repetitive peak off-state voltage VDRM : Min. 800V
- High critical rate of rise of off-state voltage(dV/dt : MIN. 1000V / μ s)
- Dual-in-line package : MOC3081 / MOC3082 /MOC3083
- Wide lead spacing package : MOC3081M / MOC3082M /MOC3083M
- Surface mounting package : MOC3081S / MOC3082S /MOC3083S
- Tape and reel packaging : MOC3081S-TA / MOC3082S-TA / MOC3083S-TA
MOC3081S-TA1 / MOC3082S-TA1 / MOC3083S-TA1
- Safety approval
UL 1577, Cert. No.E113898
CSA CA5A, Cert. No. 1020087 (CA 91533-1)
FIMKO EN/IEC 60950-1, EN/IEC 60065; Cert. No.NCS/FI 24426 M3
VDE DIN EN60747-5-2, Cert. No. 40015248
CQC GB4943.1-2011/ GB8898-2011
- RoHS Compliance
All materials be used in device are followed EU RoHS directive (No.2002/95/EC).
- MSL class1
- Halogen free option

1.2 Applications

- AC Motor Drives
- AC Motor Starters
- E.M. Contactors
- Lighting Controls
- Solenoid/Valve Controls
- Solid State Relays
- Static Power Switches
- Temperature Controls

Photocoupler MOC308X series

2. PACKAGE DIMENSIONS

2.1 MOC308X

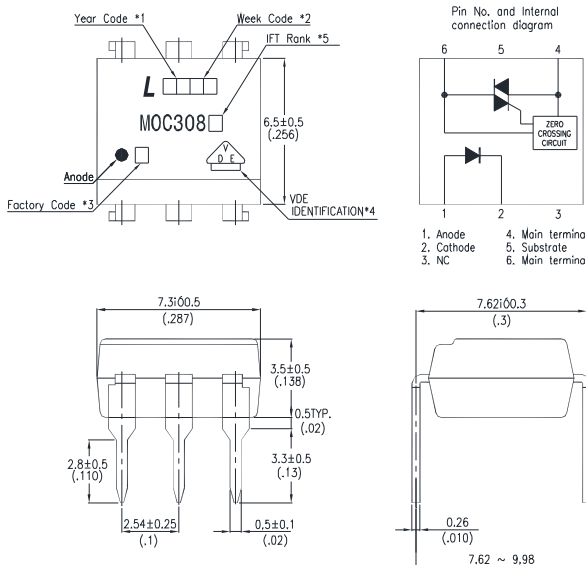

2.2 MOC308XM

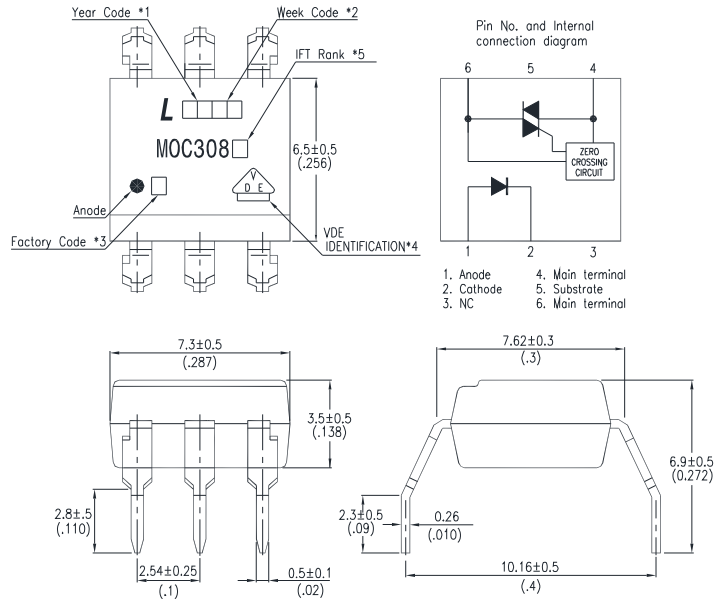

2.3 MOC308XS

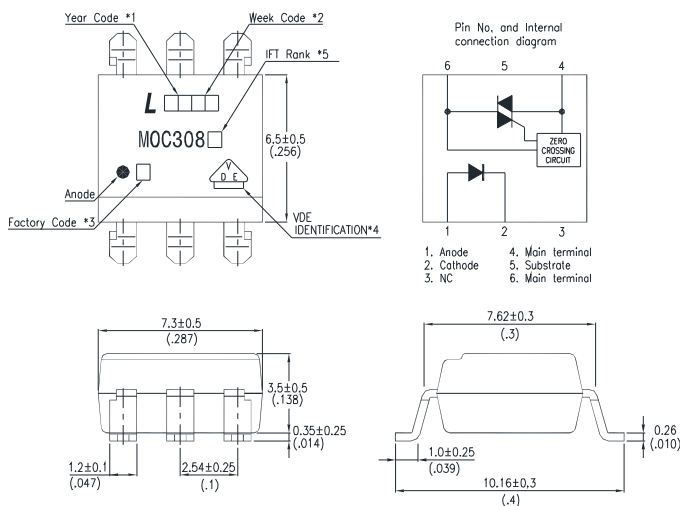

Notes :

1. 2-digit year code, example : 2016 = 16
2. 2-digit work week ranging from '01' to '53'
3. Factory identification mark shall be marked (W: China-CZ, Y: Thailand)
4. VDE option
5. I_{FT} rank

* Dimensions are in Millimeters and (Inches).

Photocoupler MOC308X series

3. TAPING DIMENSIONS

3.1 MOC308XS-TA

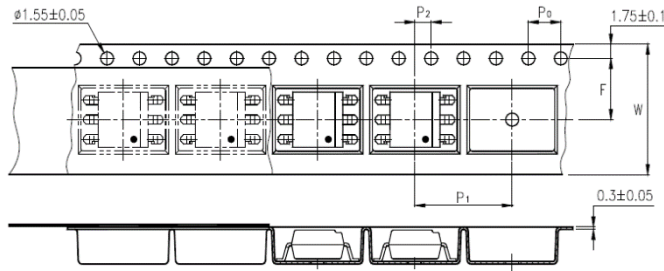

3.2 MOC308XS-TA1

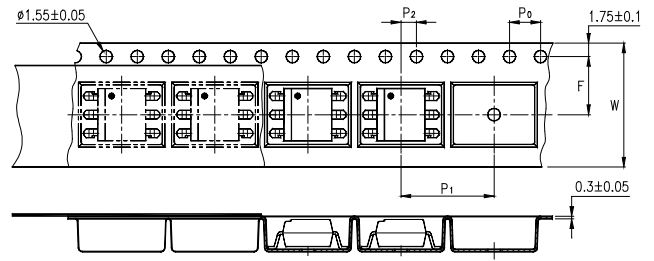

Description	Symbol	Dimension in mm (inch)
Tape wide	W	16±0.3 (0.63)
Pitch of sprocket holes	P ₀	4±0.1 (0.15)
Distance of compartment	F	7.5±0.1 (0.295)
	P ₂	2±0.1 (0.079)
Distance of compartment to compartment	P ₁	12±0.1 (0.472)

3.3 Quantities Per Reel

Package Type	MOC308XS series
Quantities (pcs)	1000

Photocoupler MOC308X series

4. RATING AND CHARACTERISTICS

4.1 Absolute Maximum Ratings at Ta=25°C

	Parameter	Symbol	Rating	Unit
Input	Forward Current	I_F	50	mA
	Reverse Voltage	V_R	6	V
	Junction Temperature	T_J	125	°C
	Power Dissipation	P	120	mW
Output	Off-State Output Terminal Voltage	V_{DRM}	800	V
	On-State RMS Current	$I_{D(RMS)}$	100	mA
	Peak Repetitive Surge Current (PW=1ms, 120pps)	I_{TSM}	1	A
	Junction Temperature	T_J	125	°C
	Output Power Dissipation	P_O	300	mW
	Total Power Dissipation	P_{tot}	330	mW
1.	Isolation Voltage	V_{iso}	5000	V_{rms}
	Operating Temperature	T_{opr}	-40 ~ +110	°C
	Storage Temperature	T_{stg}	-55 ~ +150	°C
2.	Soldering Temperature	T_{sol}	260	°C

1. AC For 1 Minute, R.H. = 40 ~ 60%

Isolation voltage shall be measured using the following method.

- (1) Short between anode and cathode on the primary side and between collector and emitter on the secondary side.
- (2) The isolation voltage tester with zero-cross circuit shall be used.
- (3) The waveform of applied voltage shall be a sine wave.

2. For 10 Seconds

Photocoupler MOC308X series

4.2 Recommended Operating Conditions (Note)

Characteristics		Symbol	Min.	Typ.	Max.	Unit
Supply Voltage		V_{AC}	-	-	480	Vac
Forward Current	MOC3081	I_F	22.5	25	30	mA
	MOC3082		15	20	30	mA
	MOC3083		7.5	10	30	mA
Operating Temperature		T_{opr}	-25	-	85	°C

Note: Recommended operating conditions are given as a design guideline to obtain expected performance of the device. Additionally, each item is an independent guideline respectively. In developing designs using this product, please confirm specified characteristics shown in this document.

Photocoupler MOC308X series

4.3 ELECTRICAL OPTICAL CHARACTERISTICS at Ta=25°C

Parameter		Symb	Min.	Typ.	Max.	Unit	Test Condition
Input	Forward Voltage	V_F	—	1.2	1.4	V	$I_F=20\text{mA}$
	Reverse Current	I_R	—	0.05	10	μA	$V_R=6\text{V}$
Output	1 Peak Blocking Current, Either Direction	I_{DRM}	—	—	500	nA	$V_{DRM} = 800\text{V}$
	Peak On-State Voltage, Either Direction	V_{TM}	—	—	3.0	V	$I_{TM}=100\text{ mA Peak}$
	2 Critical rate of Rise of Off-State Voltage	dv/dt	1000	—	—	$\text{V}/\mu\text{s}$	$V_{in}=240\text{Vrms}$
Couple	Led Trigger Current, Current Required to Latch Output, Either Direction	MOC3081	—	—	15	mA	Main Terminal Voltage = 3V
		MOC3082	—	—	10		
		MOC3083	—	—	5		
	Holding Current, Either Direction	I_H	—	200	—	μA	
ZERO CROSSING	Inhibit Voltage	V_{INH}	—	5	20	Volts	$I_F=\text{Rated } I_{FT}, \text{ MT1-MT2}$ Voltage above which device will not trigger.
	Leakage in Inhibited State	I_{DRM2}	—	—	500	μA	$I_F = \text{Rated } I_{FT}, \text{ Rated } V_{DRM}, \text{ Off State}$

*1. Test voltage must be applied within dv/dt rating.

*2. This is static dv/dt. Commutating dv/dt is a function of the load-driving thyristor(s) only.

Photocoupler MOC308X series

5. CHARACTERISTICS CURVES (TYPICAL PERFORMANCE)

Fig.1 Forward Current vs. Ambient Temperature

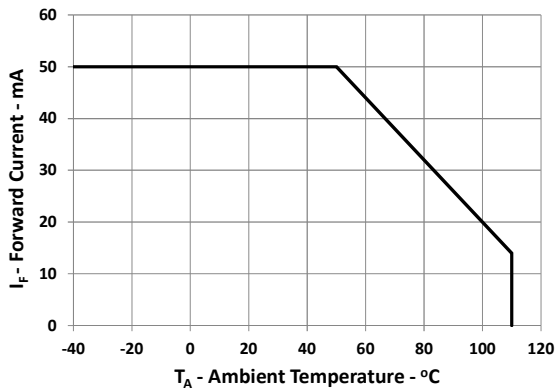

Fig.2 On-state Current vs. Ambient Temperature

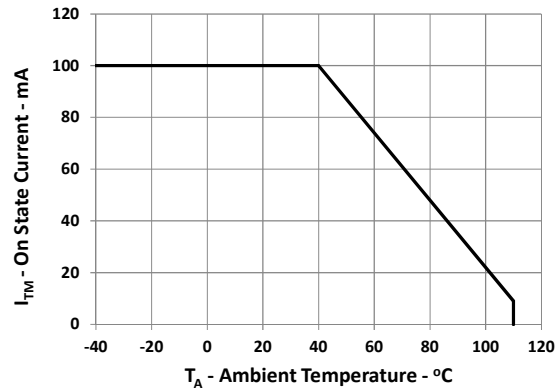

Fig.3 Normalized Trigger Current vs Ambient Temperature

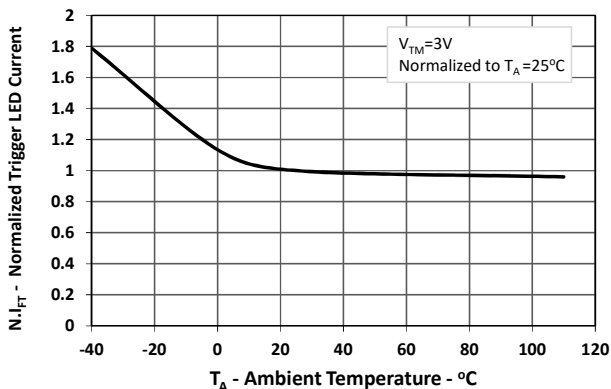

Fig.4 Forward Current vs. Forward Voltage

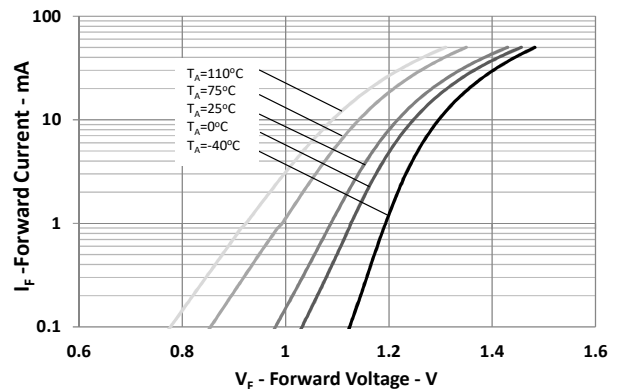

Fig.5 Normalized On-state Voltage vs Ambient Temperature

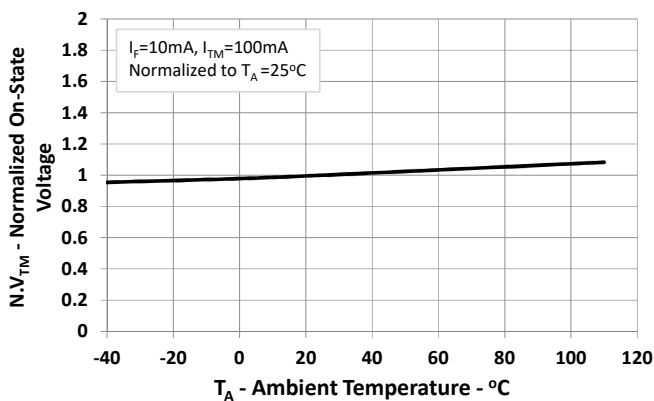
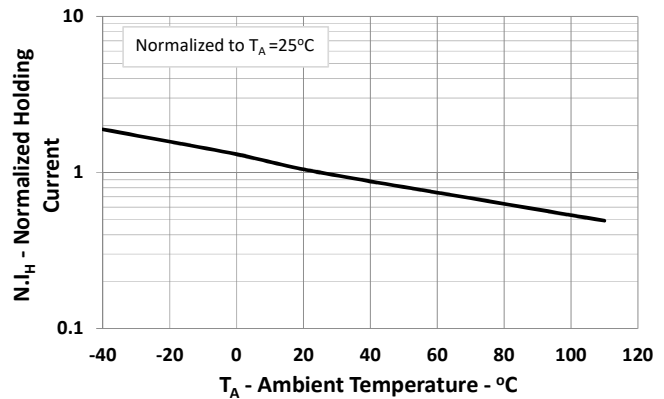

Fig.6 Normalized Holding Current vs Ambient Temperature



Photocoupler MOC308X series

Fig.7 Off-state Current vs
Ambient Temperature

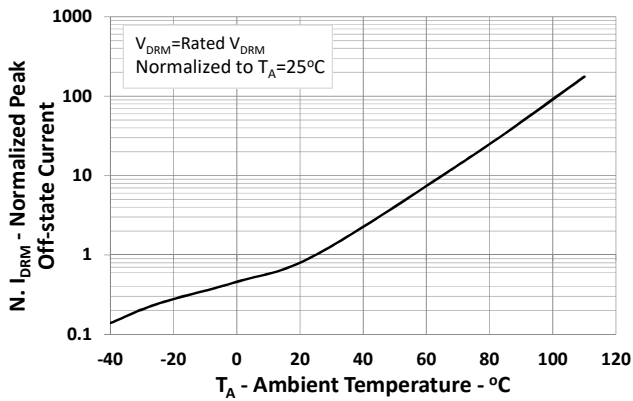

Fig.8 On-state Current vs
On-state Voltage

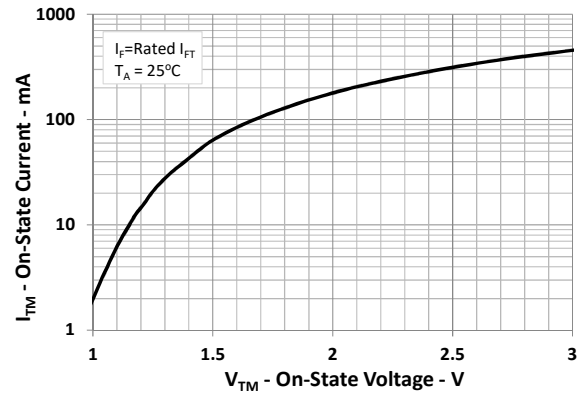
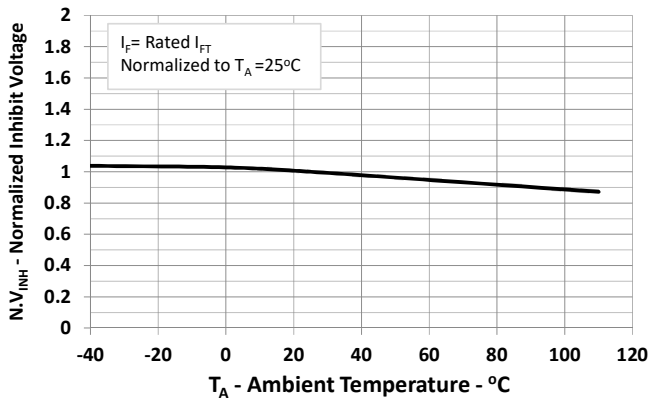

Fig.9 Inhibit Voltage vs
Ambient Temperature



Photocoupler MOC308X series

6. TEMPERATURE PROFILE OF SOLDERING

6.1 IR Reflow soldering (JEDEC-STD-020E compliant)

One time soldering reflow is recommended within the condition of temperature and time profile shown below. Do not solder more than three times.

Profile item	Conditions
Preheat	
- Temperature Min (T_{Smin})	150°C
- Temperature Max (T_{Smax})	200°C
- Time (min to max) (ts)	90±30 sec
Soldering zone	
- Temperature (T_L)	217°C
- Time (t_L)	60 sec
Peak Temperature (T_P)	260°C
Ramp-up rate	3°C / sec max.
Ramp-down rate	3~6°C / sec

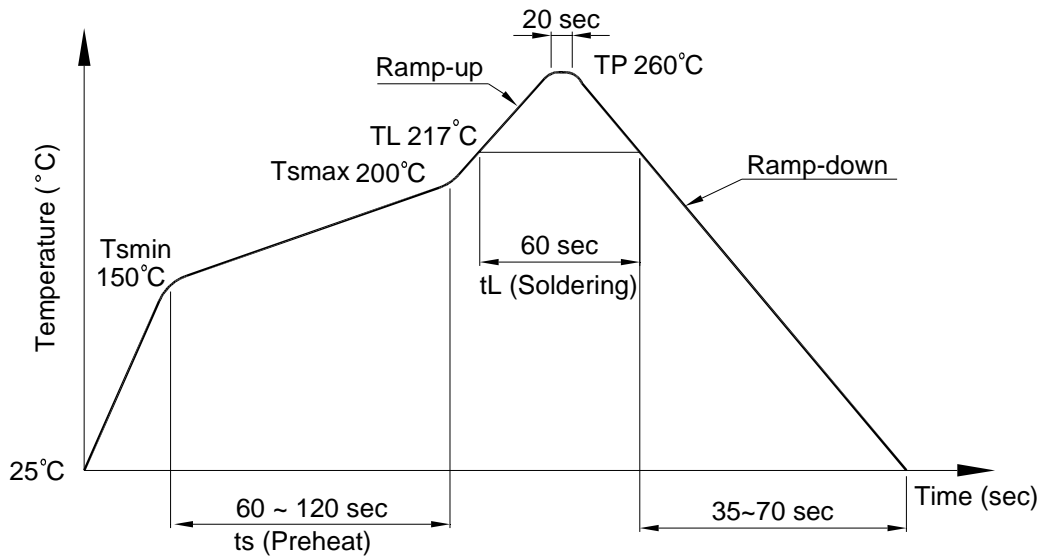

**Photocoupler
MOC308X series**

6.2 Wave soldering (JEDEC22A111 compliant)

One time soldering is recommended within the condition of temperature.

Temperature: $260 \pm 0 / -5^{\circ}\text{C}$

Time: 10 sec.

Preheat temperature: 25 to 140°C

Preheat time: 30 to 80 sec.

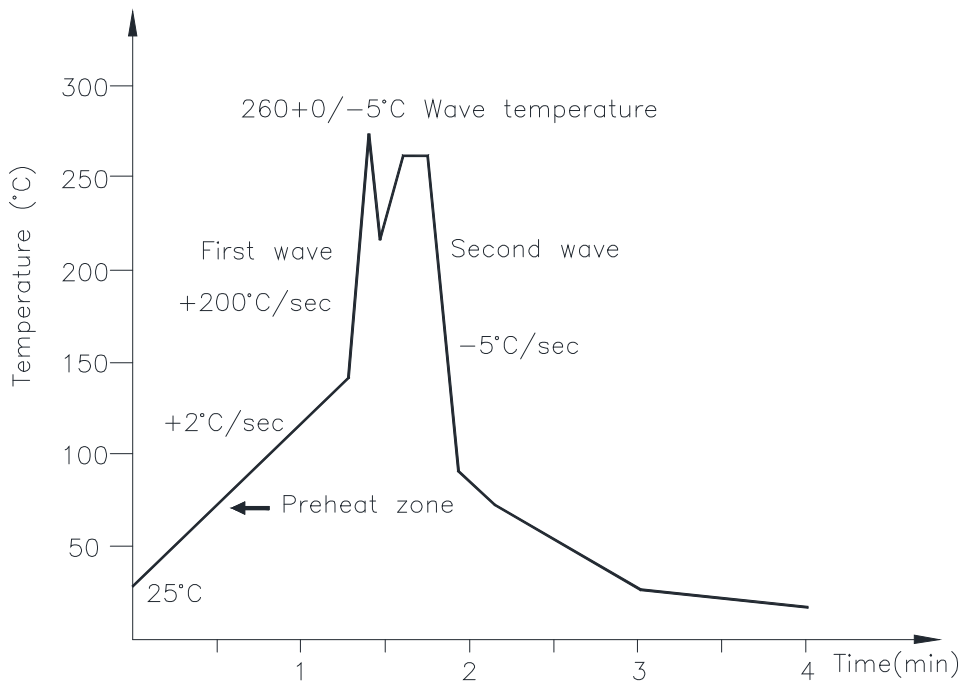

6.3 Hand soldering by soldering iron

Allow single lead soldering in every single process. One time soldering is recommended.

Temperature: $380 \pm 0 / -5^{\circ}\text{C}$

Time: 3 sec max.

**Photocoupler
MOC308X series**

7. RRECOMMENDED FOOT PRINT PATTERNS (MOUNT PAD)

Unit: mm

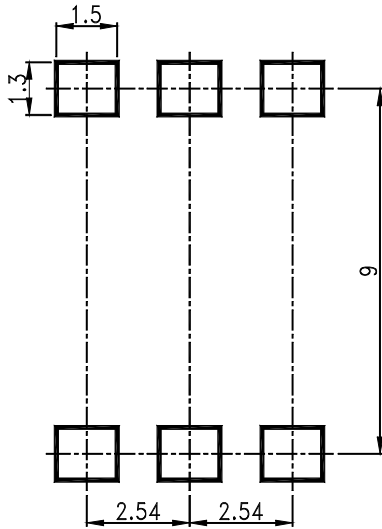

**Photocoupler
MOC308X series**

8. NAMING RULE

MOC308(X)(1)-(2)-G

DEVICE PART NUMBER (MOC308X)

Please refer to Electrical Optical Characteristics Table on Page 6

(1) FORM TYPE (S, M or none)

(2) TAPING TYPE (TA, TA1)

(3) Halogen free

Example : MOC3061S-TA1-G

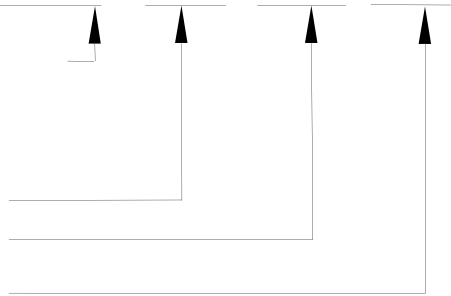

MOC308(X)(1)(2)-V-G

DEVICE PART NUMBER (MOC308X)

Please refer to Electrical Optical Characteristics Table on Page 6

(1) FORM TYPE (S, M or none)

(2) TAPING TYPE (TA, TA1)

(3) VDE option

(4) Halogen free

Example : MOC3061STA1-V-G

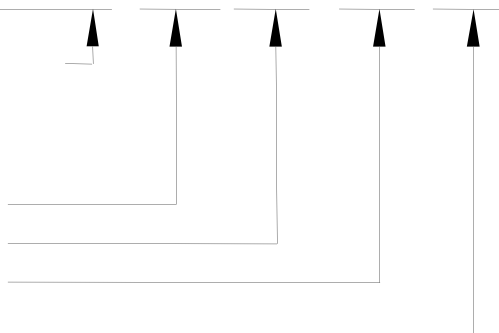

9. NOTES

- LiteOn is continually improving the quality, reliability, function or design and LiteOn reserves the right to make changes without further notices.
- The products shown in this publication are designed for the general use in electronic applications such as office automation equipment, communications devices, audio/visual equipment, electrical application and instrumentation.
- For equipment/devices where high reliability or safety is required, such as space applications, nuclear power control equipment, medical equipment, etc, please contact our sales representatives.
- When requiring a device for any "specific" application, please contact our sales in advice.
- If there are any questions about the contents of this publication, please contact us at your convenience.
- The contents described herein are subject to change without prior notice.
- Immerge unit's body in solder paste is not recommended.