

TRR

MAIN FEATURES

- Miniature, cost-effective switching solution.
- State of the art capsule designs.
- Molded construction for compatibility with automatic board processing.
- Epoxy-molded dual-in-line package.
- Completely washable.

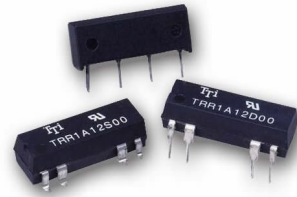

APPLICATIONS

- Measuring equipment, Communication equipment, Control equipment, Appliances, etc.

ORDERING INFORMATION

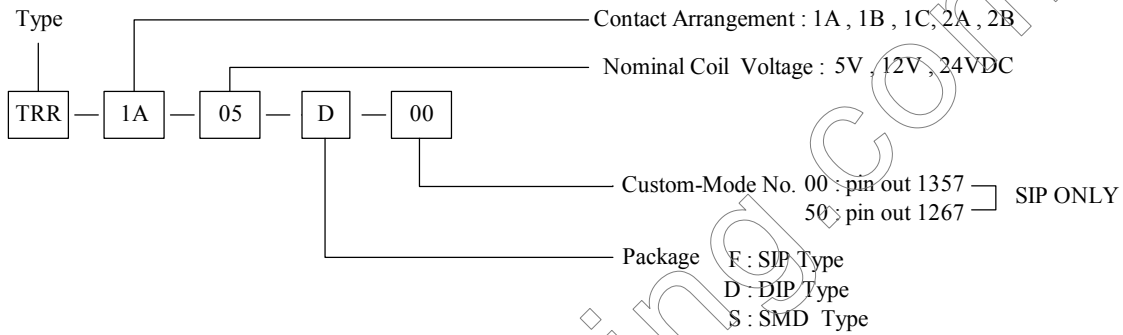

DIMENSION (unit:mm)

DRILLING (unit:mm)

WIRING DIAGRAM

SIP Type

TRR-00
(00:PIN OUT 1357)

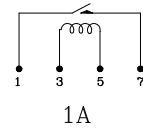
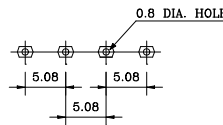
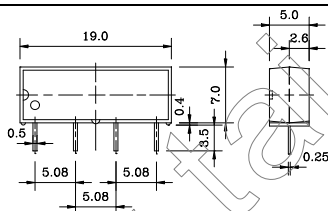

TRR-50
(50:PIN OUT 1267)

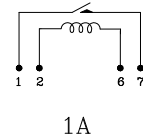
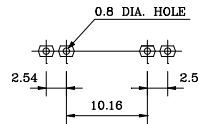
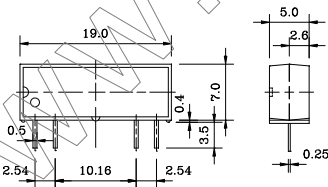

DIP Type

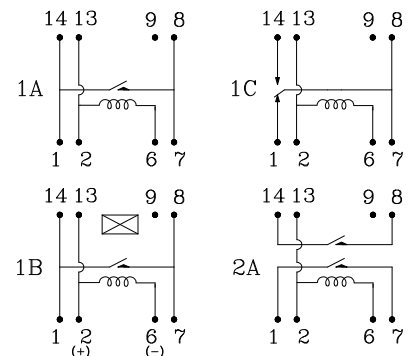
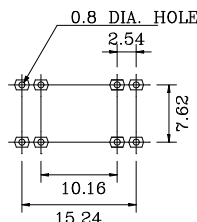
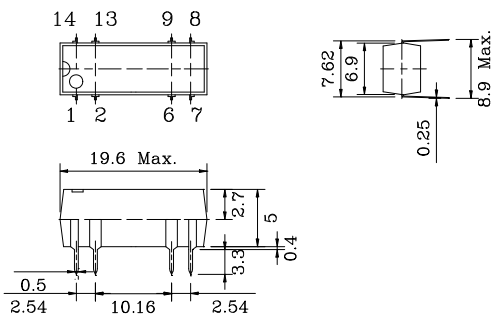

■ DIMENSION (unit:mm)

■ DRILLING (unit:mm)

■ WIRING DIAGRAM

SMD Type

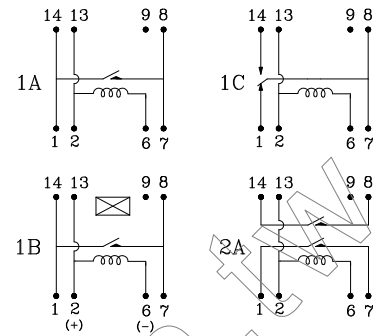
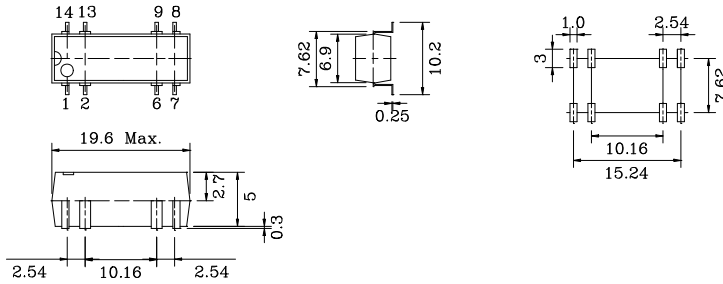

■ COIL DATA CHART (AT20°C)

■ REFERENCE DATA

Coil Sensitivity	Nominal Voltage (VDC)	Max. Operate Voltage (VDC)	Nominal Current (mA)	Coil Resistance ($\Omega \pm 10\%$)	Power Consumption (mW)	Pull-In Voltage (VDC)	Drop-Out Voltage (VDC)
TRR-1A TRR-1B	5	6	10	500	50	3.75	0.8
	12	14.5	12	1000	144	9.0	1.0
	24	29	11.2	2150	268	18.0	2.0
TRR-1C	5	11	25	200	125	3.75	0.8
	12	20	24	500	288	9.0	1.0
	24	32	11.2	2150	268	18.0	2.0
TRR-2A	5	11	35.7	140	179	3.75	0.8
	12	20	24	500	288	9.0	1.0
	24	32	11.2	2150	268	18.0	2.0

Coil Temperature Rise

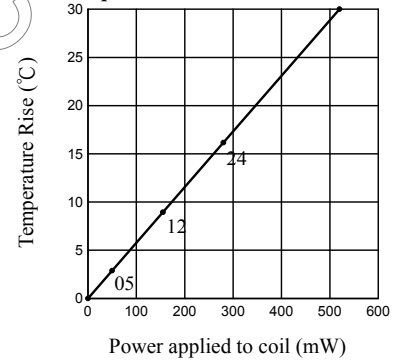

■ PERFORMANCE

Contact form	\sphericalangle A/1B/2A	1C
Switching Current	0.5ADC Max.	0.2ADC Max.
Carry Current	1.0ADC Max.	0.5ADC Max.
Switching Power	10VA Max.	3VA Max.
Electrical Life	1×10^8 (10VDC 10mA)	5×10^7 (5VDC 1mA)
Contact Resistance	150m Ω Max.	
Operation Time (including bounce time)	1.0msec. Max.	
Release Time (including bounce time)	1.0msec. Max.	
Maximum Voltage	100VDC Max.	30VAC/DC Max.
Insulation Resistance	$10^{10} \Omega$ Min.	$10^9 \Omega$ Min.
Dielectric Strength	Between coil & contact	1400VDC
	Between contacts	250VDC
Temperature Range	Operating Temp.	-40 to +85°C
	Storage Temp.	-55 to +125°C
Shock Resistance	30G Min.	
UL File No.	E156521	

Time Characteristic (Operation Time)

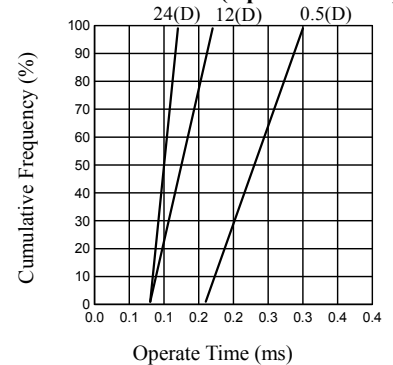

Time Characteristic (Release Time)

