



DC COMPONENTS CO., LTD.
RECTIFIER SPECIALISTS

P6KE6.8
THRU
P6KE440CA

TECHNICAL SPECIFICATIONS OF TRANSIENT VOLTAGE SUPPRESSOR

VOLTAGE RANGE - 6.8 to 440Volts PEAK PULSE POWER - 600 Watts

FEATURES

- * Glass passivated junction
- * 600 Watts Peak Pulse Power capability on 10/1000 μ s waveform
- * Excellent clamping capability
- * Low zener impedance
- * Fast response time

MECHANICAL DATA

- * Case: Molded plastic
- * Epoxy: UL 94V-0 rate flame retardant
- * Lead: MIL-STD-202E, Method 208 guaranteed
- * Polarity: Color band denotes positive end (cathode) except bidirectional types
- * Mounting position: Any
- * Weight: 0.4 gram

MAXIMUM RATINGS AND ELECTRICAL CHARACTERISTICS

Ratings at 25°C ambient temperature unless otherwise specified.
Single phase, half wave, 60 Hz, resistive or inductive load,
For capacitive load, derate current by 20%.

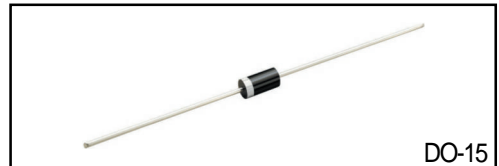

DO-15

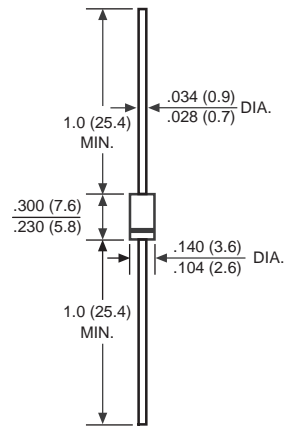

Dimensions in inches and (millimeters)

DEVICES FOR BIPOLAR APPLICATIONS

For Bidirectional use C or CA suffix (e.g. P6KE6.8C, P6KE440CA).

Electrical characteristics apply in both directions

	SYMBOL	VALUE	UNITS
Peak Pulse Power Dissipation on 10/1000 μ s waveform (Note 1, FIG. 1)	P _{PPM}	Minimum 600	Watts
Steady State Power Dissipation at T = 75°C Lead Lengths .375"(9.5mm) (Note 2)	P _{M(AV)}	5.0	Watts
Peak Forward Surge Current, 8.3ms single half sine-wave superimposed on rated load(JEDEC Method) (Note 3)	I _{FSM}	100	Amps
Maximum Instantaneous Forward Voltage at 50A for Unidirectional only (Note 4)	V _F	3.5/6.5	Volts
Operating and Storage Temperature Range	T _J , T _{STG}	-55 to + 175	°C

- NOTES : 1. Non-repetitive current pulse, per Fig.3 and derated above TA = 25°C per Fig. 2.
2. Mounted on Copper Leaf area of 1.6 X 1.6" (40 X 40mm) per Fig. 5
3. 8.3ms single half sine-wave or equivalent square wave, duty cycle = 4 pulses per minute maximum.
4. VF = 3.5V max. for devices of V_(BR) ≤ 200V max. and VF = 6.5V max. for devices of V_(BR) > 200V.

RATING AND CHARACTERISTIC CURVES (P6KE6.8 THRU P6KE440CA)

FIG. 1 - PEAK PULSE POWER RATING CURVE

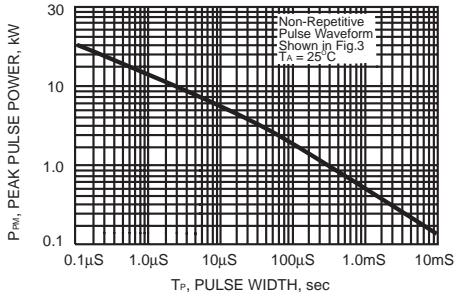

FIG. 2 - PULSE DERATING CURVE

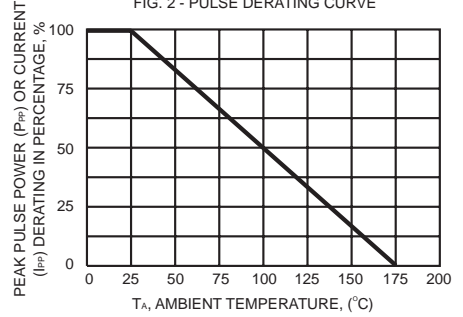

FIG. 3 - PULSE WAVEFORM

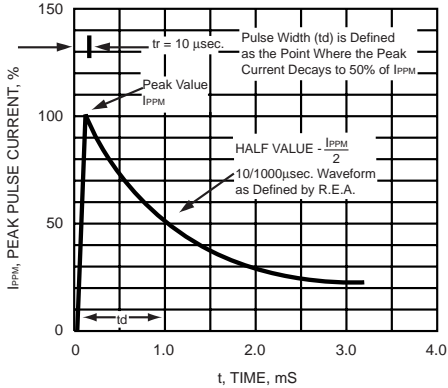

FIG. 4 - TYPICAL JUNCTION CAPACITANCE

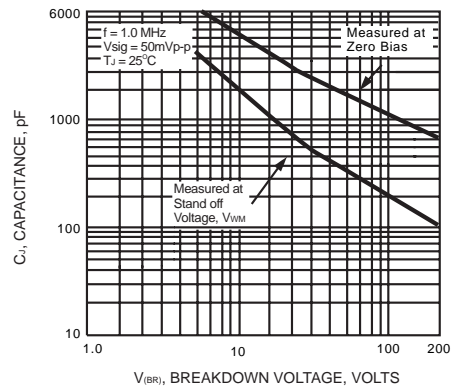

FIG. 5 - STEADY STATE POWER DERTING CURVE

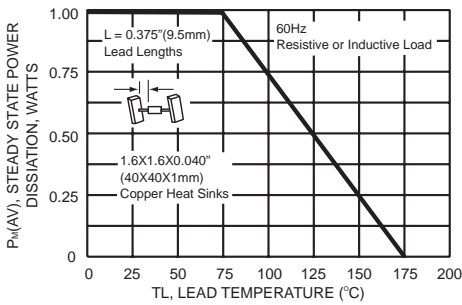

FIG. 6 - MAXIMUM NON-REPETITIVE FORWARD SURGE CURRENT UNIDIRECTIONAL

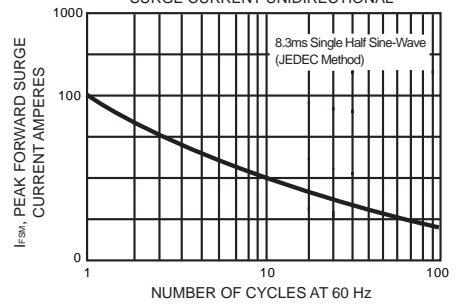
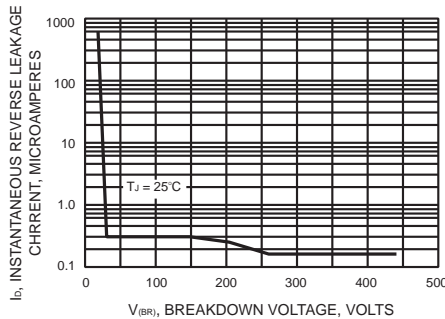

FIG. 7 - TYPICAL REVERSE LEAKAGE CHARACTERISTICS



P6KE (600W) SERIES TRANSIENT VOLTAGE SUPPRESSORS

TYPE	Reverse Stand-off Voltage	Breakdown Voltage @ I _T		Test Current	Maximum Reverse Leakage @ V _{RWM}		Maximum Clamping Voltage @ I _{PP}	Maximum Peak Pulse Current
	V _{RWM}	V _{BR}		I _T	I _R		V _c	I _{PP}
		Min.	Max.		UNI-	BI-		
	V	V	V	mA	μA	μA	V	A
P6KE6.8	5.50	6.12	7.48	10	1000	2000	10.8	56.0
P6KE6.8A	5.80	6.45	7.14	10	1000	2000	10.5	57.0
P6KE7.5	6.05	6.75	8.25	10	500	1000	11.7	51.0
P6KE7.5A	6.40	7.13	7.88	10	500	1000	11.3	53.0
P6KE8.2	6.63	7.38	9.02	10	200	400	12.5	48.0
P6KE8.2A	7.02	7.79	8.61	10	200	400	12.1	50.0
P6KE9.1	7.37	8.19	10.0	1	50	100	13.8	44.0
P6KE9.1A	7.78	8.65	9.50	1	50	100	13.4	45.0
P6KE10	8.10	9.00	11.0	1	10	20	15.0	40.0
P6KE10A	8.55	9.50	10.5	1	10	20	14.5	41.0
P6KE11	8.92	9.90	12.1	1	5	10	16.2	37.0
P6KE11A	9.40	10.5	11.6	1	5	10	15.6	38.0
P6KE12	9.72	10.8	13.2	1	5		17.3	35.0
P6KE12A	10.2	11.4	12.6	1	5		16.7	36.0
P6KE13	10.5	11.7	14.3	1	5		19.0	32.0
P6KE13A	11.1	12.4	13.7	1	5		18.2	33.0
P6KE15	12.1	13.5	16.5	1	5		22.0	27.0
P6KE15A	12.8	14.3	15.8	1	5		21.2	28.0
P6KE16	12.9	14.4	17.6	1	5		23.5	26.0
P6KE16A	13.6	15.2	16.8	1	5		22.5	27.0
P6KE18	14.5	16.2	19.8	1	5		26.5	23.0
P6KE18A	15.3	17.1	18.9	1	5		25.2	24.0
P6KE20	16.2	18.0	22.0	1	5		29.1	21.0
P6KE20A	17.1	19.0	21.0	1	5		27.7	22.0
P6KE22	17.8	19.8	24.2	1	5		31.9	19.0
P6KE22A	18.8	20.9	23.1	1	5		30.6	20.0
P6KE24	19.4	21.6	26.4	1	5		34.7	17.0
P6KE24A	20.5	22.8	25.2	1	5		33.2	18.0
P6KE27	21.8	24.3	29.7	1	5		39.1	15.0
P6KE27A	23.1	25.7	28.4	1	5		37.5	16.0
P6KE30	24.3	27.0	33.0	1	5		43.5	14.0
P6KE30A	25.6	28.5	31.5	1	5		41.4	14.4
P6KE33	26.8	29.7	36.3	1	5		47.7	12.6
P6KE33A	28.2	31.4	34.7	1	5		45.7	13.2
P6KE36	29.1	32.4	39.6	1	5		52.0	11.6
P6KE36A	30.8	34.2	37.8	1	5		49.9	12.0
P6KE39	31.6	35.1	42.9	1	5		56.4	10.6
P6KE39A	33.3	37.1	41.0	1	5		53.9	11.2
P6KE43	34.8	38.7	47.3	1	5		61.9	9.6
P6KE43A	36.8	40.9	45.2	1	5		59.3	10.1
P6KE47	38.1	42.3	51.7	1	5		67.8	8.9
P6KE47A	40.2	44.7	49.4	1	5		64.8	9.3

P6KE (600W) SERIES TRANSIENT VOLTAGE SUPPRESSORS

TYPE	Reverse Stand-off Voltage	Breakdown Voltage @ I _T		Test Current	Maximum Reverse Leakage @ V _{RWM}		Maximum Clamping Voltage @ I _{PP}	Maximum Peak Pulse Current
		V _{BR}			I _T	I _R		
	V _{RWM}	Min.	Max.	UNI-		BI-		
	V	V	V	μA	μA	V _c	I _{PP}	
P6KE51	41.3	45.9	56.1	1	5	73.5	8.2	
P6KE51A	43.6	48.5	53.6	1	5	70.1	8.6	
P6KE56	45.6	50.4	61.6	1	5	80.5	7.4	
P6KE56A	47.8	53.2	58.8	1	5	77.0	7.8	
P6KE62	50.2	55.8	68.2	1	5	89.0	6.8	
P6KE62A	53.0	58.9	65.1	1	5	85.0	7.1	
P6KE68	55.1	61.2	74.8	1	5	98.0	6.1	
P6KE68A	58.1	64.6	71.4	1	5	92.0	6.5	
P6KE75	60.7	67.5	82.5	1	5	108	5.5	
P6KE75A	54.1	71.3	78.8	1	5	103	5.8	
P6KE82	66.4	73.8	90.2	1	5	118	5.1	
P6KE82A	70.1	77.9	86.1	1	5	113	5.3	
P6KE91	73.7	81.9	100	1	5	131	4.5	
P6KE91A	77.8	86.5	95.5	1	5	125	4.8	
P6KE100	81.0	90.0	110	1	5	144	4.2	
P6KE100A	85.5	95.0	105	1	5	137	4.4	
P6KE110	89.2	99.0	121	1	5	158	3.8	
P6KE110A	94.0	105	116	1	5	152	4.0	
P6KE120	97.2	108	132	1	5	173	3.5	
P6KE120A	102	114	126	1	5	165	3.6	
P6KE130	105	117	143	1	5	187	3.2	
P6KE130A	111	124	137	1	5	179	3.3	
P6KE150	121	135	165	1	5	215	2.8	
P6KE150A	128	143	158	1	5	207	2.9	
P6KE160	130	144	176	1	5	230	2.6	
P6KE160A	136	152	168	1	5	219	2.7	
P6KE170	138	153	187	1	5	244	2.5	
P6KE170A	145	162	179	1	5	234	2.6	
P6KE180	146	162	198	1	5	258	2.3	
P6KE180A	154	171	189	1	5	246	2.4	
P6KE200	162	180	220	1	5	287	2.1	
P6KE200A	171	190	210	1	5	274	2.2	
P6KE220	175	198	242	1	5	344	1.8	
P6KE220A	185	209	231	1	5	328	1.9	
P6KE250	202	225	275	1	5	360	1.7	
P6KE250A	214	237	263	1	5	344	1.8	
P6KE300	243	270	330	1	5	430	1.4	
P6KE300A	256	285	315	1	5	414	1.5	
P6KE350	284	315	385	1	5	504	1.2	
P6KE350A	300	332	368	1	5	482	1.3	
P6KE400	324	360	440	1	5	574	1.05	
P6KE400A	342	380	420	1	5	548	1.1	
P6KE440	356	396	484	1	5	631	0.99	
P6KE440A	376	418	462	1	5	602	1.04	

NOTES: 1. V_{BR} measured after I_T applied for 300μs. I_T = Square Wave Pulse or equivalent.

2. For Bidirectional use "C" or "CA" Suffix for all types (e.g.: P6KE6.8C, P6KE6.8CA, P6KE440C, P6KE440CA).
Electrical characteristics apply in both directions.

3. For bidirectional types having V_{RWM} of 10 volts and less, the I_D limit is doubled.

Disclaimer

Any Customer or user of this document or products described herein in such applications shall assume all risks of such use and will agree to hold *DC COMPONENTS* harmless against all damages.

DC COMPONENTS disclaims any and all liability arising out of the application or use of any product, including consequential or incidental damages. Statement regarding the suitability of products for certain types of applications are based on *DC COMPONENTS*'s knowledge of typical requirements that are often placed on *DC COMPONENTS* products in generic applications. Such statements are not binding statements about the suitability of products for a particular application. It is the customer's responsibility to validate that a particular product with the properties described in the product specification is suitable for use in a particular application.

DC COMPONENTS reserve the right to make modifications, enhancements, improvements, corrections or other changes without further notice to this document and any product described herein, and disclaim any and all liability for any errors, inaccuracies or incompleteness contained in any datasheet or in any other disclosure relating to any product. Parameters provided in datasheets and specifications may vary in different applications and performance may vary over time. All operating parameters, including typical parameters, must be validated for each customer application by the customer's technical experts. Product specifications do not expand or otherwise modify *DC COMPONENTS*'s terms and conditions of purchase, including but not limited to the warranty expressed therein.

Unless otherwise in writing, *DC COMPONENTS* products are intended for use as general electronic components in standard applications (eg: Consumer electronic, Computer equipment, Office equipment, etc.), and not recommended for use in a high specific application where a failure or malfunction of the device could result in human injury or death (eg: Aerospace equipment, Submarine cables, Combustion equipment, Safety devices, Life support systems, etc.)

Customers using or selling *DC COMPONENTS* products not expressly indicated for use in such applications do so at their own risk. If customer intended to use *DC COMPONENTS* standard quality grade devices for applications not envisioned by *DC COMPONENTS*, please contact our sales representatives in advance.



DC COMPONENTS CO., LTD.